



KĀDANT

Pioneering Industrial Solutions
for a Sustainable Future

Kadant Investor Day | December 12, 2024

Forward-Looking Statements

The following constitutes a “Safe Harbor” statement under the Private Securities Litigation Reform Act of 1995: This presentation contains forward-looking statements that involve a number of risks and uncertainties, including forward-looking statements about our future financial and operating performance, demand for our products, and economic and industry outlook. These forward-looking statements represent our expectations as of December 12, 2024. We undertake no obligation to publicly update any forward-looking statement, whether as a result of new information, future events, or otherwise. These forward-looking statements are subject to known and unknown risks and uncertainties that may cause our actual results to differ materially from these forward-looking statements as a result of various important factors, including those set forth under the heading “Risk Factors” in Kadant’s annual report on Form 10-K for the fiscal year ended December 30, 2023 and subsequent filings with the Securities and Exchange Commission. These include risks and uncertainties relating to adverse changes in global and local economic conditions; the variability and difficulty in accurately predicting revenues from large capital equipment and systems projects; our acquisition strategy; levels of residential construction activity; reductions by our wood processing customers of their capital spending or production of oriented strand board; changes to the global timber supply; development and use of digital media; cyclical economic conditions affecting the global mining industry; demand for coal, including economic and environmental risks associated with coal; failure of our information systems or breaches of data security and

cybertheft; implementation of our internal growth strategy; supply chain constraints, inflationary pressure, price increases and shortages in raw materials; competition; changes to tax laws and regulations; our ability to successfully manage our manufacturing operations; disruption in production; future restructurings; loss of key personnel and effective succession planning; protection of intellectual property; climate change; adequacy of our insurance coverage; global operations; policies of the Chinese government; the variability and uncertainties in sales of capital equipment in China; currency fluctuations; changes to government regulations and policies around the world; compliance with government regulations and policies and compliance with laws; environmental laws and regulations; environmental, health and safety laws and regulations impacting the mining industry; our debt obligations; restrictions in our credit agreement and note purchase agreement; soundness of financial institutions; fluctuations in our share price; and anti-takeover provisions.

The following slides and related commentary address certain current goals and targets for Kadant over a five year period. There can be no assurance that these goals and targets will be achieved and, in addition to the general risks and uncertainties of our business, they are based on a number of assumptions that may or may not prove accurate or achievable. These goals and targets may change at any time and we undertake no obligation to update them.

Use of Non-GAAP Financial Measures & Company Estimates

NON-GAAP FINANCIAL MEASURES

In addition to the financial measures prepared in accordance with U.S. generally accepted accounting principles (GAAP), we use certain non-GAAP financial measures, including increases or decreases in revenue excluding the effect of acquisitions and foreign currency translation (organic revenue), adjusted operating income, adjusted net income, adjusted EPS, adjusted earnings before interest, taxes, depreciation, and amortization (adjusted EBITDA), adjusted EBITDA margin, adjusted selling, general and administrative (SG&A) expenses, adjusted SG&A as a percentage of revenue, free cash flow, and adjusted free cash flow. All references to EPS (earnings per share) are to our EPS as calculated on a diluted basis.

Specific non-GAAP financial measures have been marked with an * (asterisk) within this presentation. A reconciliation of those numbers to the most directly comparable GAAP financial measures is shown in the Appendix.

We believe these non-GAAP financial measures, when taken together with the corresponding GAAP financial measures, provide meaningful supplemental information regarding our performance by excluding certain items that may not be indicative of our core business, operating results, or future outlook. We believe the inclusion of such measures helps investors gain an understanding of our underlying operating performance and future prospects, consistent with how management measures and forecasts our performance, especially when comparing such results to

previous periods or forecasts and to the performance of our competitors. Such measures are also used by us in our financial and operating decision-making and for compensation purposes. We also believe this information is responsive to investors' requests and gives them an additional measure of our performance.

The non-GAAP financial measures included in this presentation are not meant to be considered superior to or a substitute for the results of operations or cash flows prepared in accordance with GAAP. In addition, the non-GAAP financial measures included in this presentation have limitations associated with their use as compared to the most directly comparable GAAP measures, in that they may be different from, and therefore not comparable to, similar measures used by other companies.

COMPANY ESTIMATES

We make estimates of global market share, revenue and market opportunities and total market size for various product lines. These estimates are based on Company information and are not derived from published studies or other market data unless otherwise noted.

Pioneering Industrial Solutions for a Sustainable Future

KADANT INVESTOR DAY 2024



JEFFREY L. POWELL

President and Chief Executive Officer

KĀDANT

About Kadant

DELIVERING SMART & EFFICIENT SOLUTIONS TO PROCESS INDUSTRIES

Our products and services play an integral role in enhancing efficiency, optimizing energy utilization, and maximizing productivity in process industries while helping our customers advance their sustainability initiatives.

| | | | |
|-------------------------|------------------------------|----------------------------|----------------------------------|
| REVENUE \$958 | Adj. EBITDA* \$201 | EMPLOYEES ~3,500 | LOCATIONS 20 countries |
|-------------------------|------------------------------|----------------------------|----------------------------------|

Revenue and adjusted EBITDA* are for FY 2023 and in USD millions.

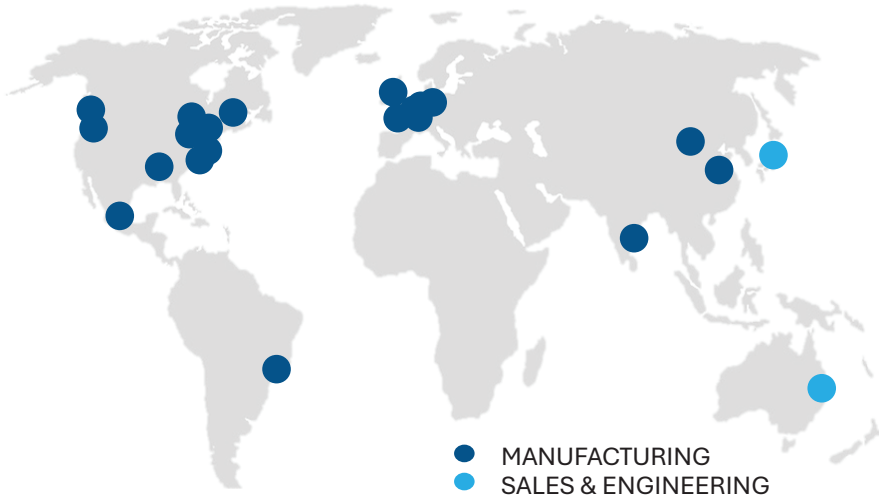

Headquartered in Westford, Massachusetts, with 22 major manufacturing locations around the world.

Kadant Leadership Team & Business Leaders

TODAY'S PRESENTERS



JEFF POWELL
President & CEO



WES MARTZ
Vice President, Flow Control Americas



BILAL MEHMOOD
President
Kadant Solutions



CHAD GREENFIELD
Commercial Director
Syntron Material Handling



CRAIG HELEY
President
Kadant PAAL



MICHAEL COLWELL
Senior Vice President,
Industrial Processing



CHRIS DEMLER
President
Kadant Black Clawson



DARA MITCHELL
SVP, Corporate Development



MIKE MCKENNEY
Executive Vice President & CFO

ADDITIONAL TEAM MEMBERS



PETER FLYNN
Senior Vice President



STACY KRAUSE
SVP, General Counsel & Secretary

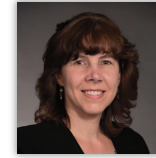

DEB SELWOOD
SVP, Chief Accounting Officer



ANDY BLANCHARD
Vice President,
Material Handling



FRED WESTERHOUT
Vice President,
Flow Control



ORRIN BEAN
Treasurer

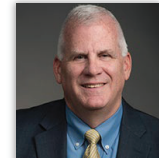

THOMAS MARTIN
Vice President,
Tax

Agenda

INVESTOR DAY 2024

1

Kadant Business Overview
Jeff Powell, President & CEO

2

Flow Control Segment
Wes Martz, Vice President, Flow Control Americas
Bilal Mehmood, President, Kadant Solutions

3

Material Handling Segment
Chad Greenfield, Commercial Director, Syntron
Craig Heley, President, Kadant PAAL

4

Industrial Processing Segment
Michael Colwell, SVP, Industrial Processing
Chris Demler, President, Kadant Black Clawson

5

Acquisition Strategy & 80/20
Dara Mitchell, SVP, Corporate Development

6

Delivering Sustainable Value
Mike McKenney, Executive Vice President & CFO

7

Summary & Conclusion
Jeff Powell, President & CEO

8

Q&A and Product Demonstrations

Kadant's DNA

TECHNOLOGY THAT DRIVES SUSTAINABLE INDUSTRIAL PROCESSING®

- Stable business model with recurring revenue resulting from high-impact solutions and “sticky” customer relationships
- Over 60% of revenue from aftermarket parts
- Growing end markets driven by global macro trends
- Decentralized structure, asset-light operating model
- Excellent financial performance and free cash flow* generation
- Disciplined capital allocation and proven record of value-creating acquisitions
- Experienced management team

Global Platform, Local Presence

EMPLOYING A DECENTRALIZED OPERATING MODEL AROUND THE WORLD



FY 2023 revenue based on customer location.

Advantages of Geographic and Market Diversity

2023 REVENUE SOURCE

REVENUE BY CUSTOMER LOCATION

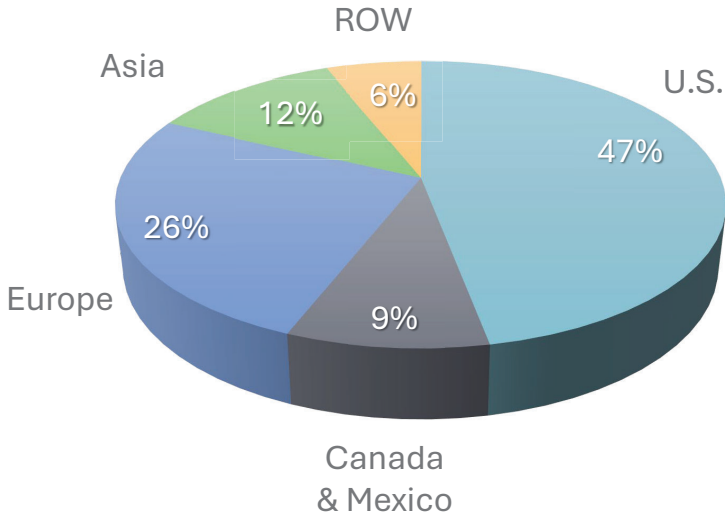

REVENUE BY END MARKET

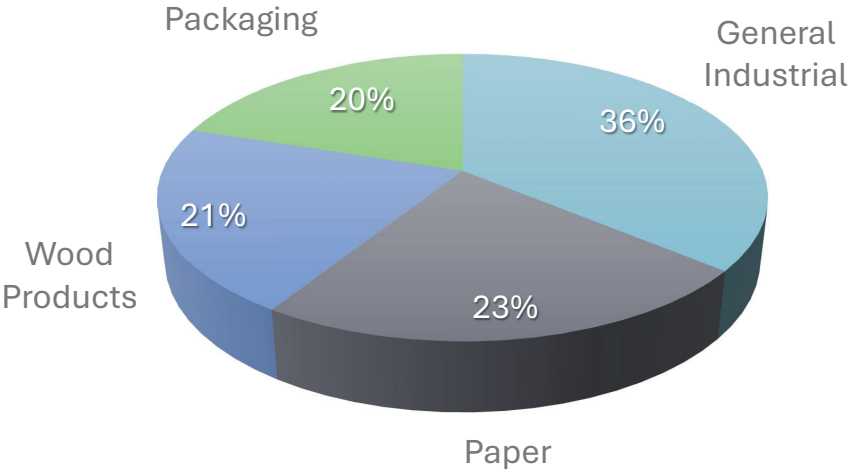

Strategic Operating Segments

TECHNOLOGY THAT DRIVES SUSTAINABLE INDUSTRIAL PROCESSING®

FLOW CONTROL

Custom-engineered products and technologies that impact the flow of fluids.

% REVENUE¹

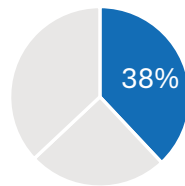

% AFTERMARKET²

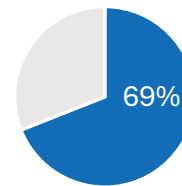

PRIMARY MARKETS

- Packaging
- Converting
- Energy
- Food & Beverage
- Defense

MATERIAL HANDLING

Products used to handle bulk and discrete materials for secondary processing.

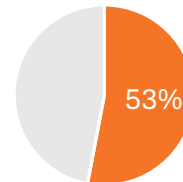
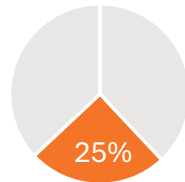

- Aggregates
- Mining
- Food
- Packaging
- Waste Management

INDUSTRIAL PROCESSING

Products used to process wood and virgin and recycled fibers.

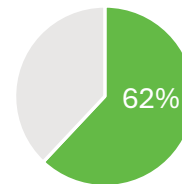
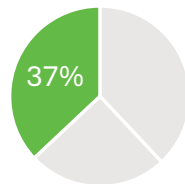

- Packaging
- Tissue
- Recycling
- Engineered wood
- Dimensional lumber

Revenue by Operating Segment

DIVERSIFYING OUR STRATEGIC MIX

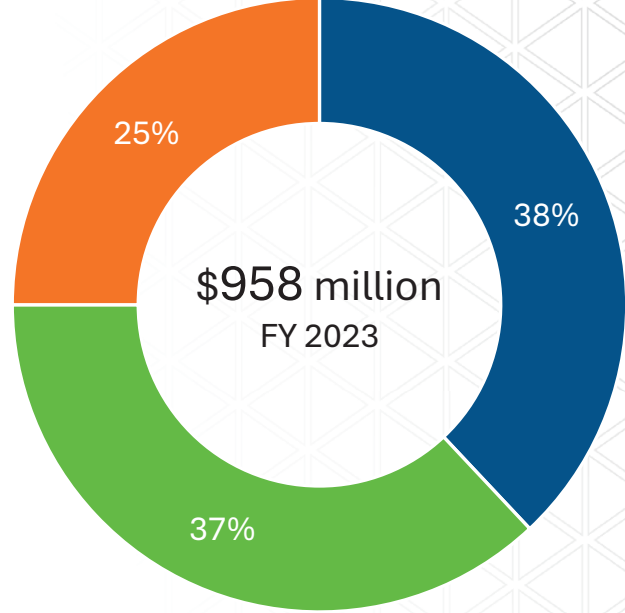
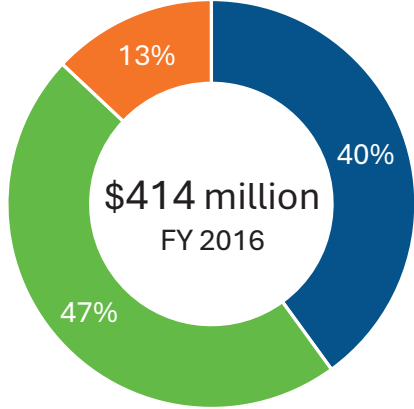
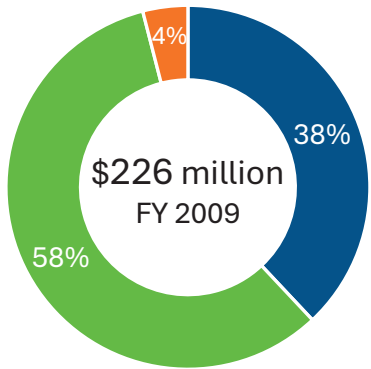

■ Flow Control ■ Industrial Processing ■ Material Handling

Steady and Predictable Recurring Revenue

BUSINESS MODEL SUPPORTS HIGHER MARGINS AND STRONG CASH FLOW

FY 2023

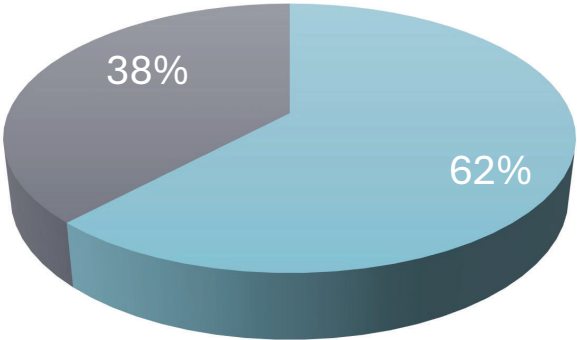

■ Aftermarket Parts ■ Capital

Q3 YTD 2024

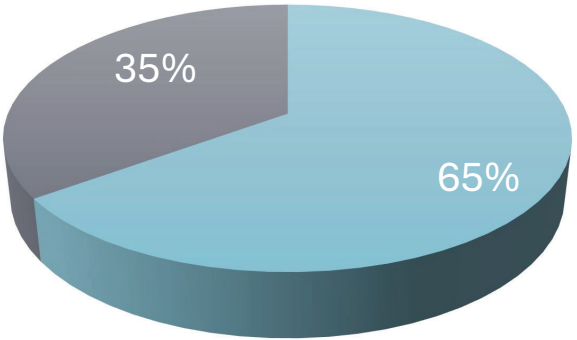

■ Aftermarket Parts ■ Capital

FLOW CONTROL

Accelerating profitable revenue growth via innovation, geographic expansion, and market penetration.



WES MARTZ

Vice President, Flow Control Americas

KADANT

Flow Control

PRODUCT LINES

Custom-engineered products, systems, and technologies used to enable fluid, power, and data transfer to optimize energy utilization, improve machine runnability, and enhance productivity.

FLUID HANDLING

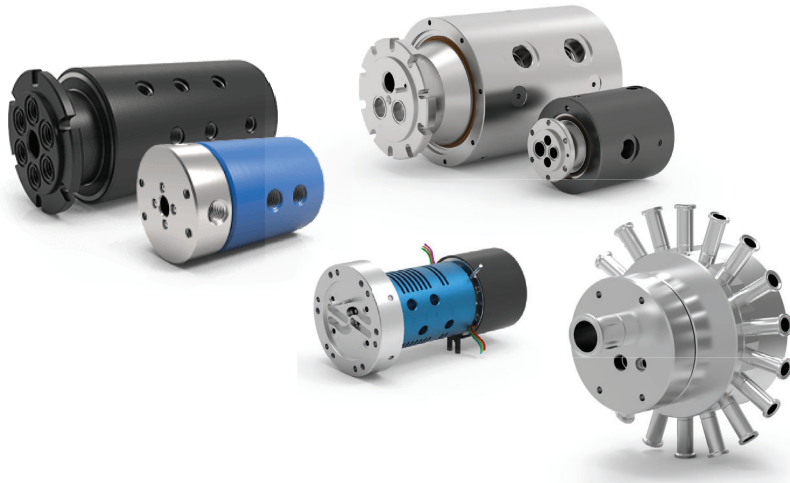

DOCTORING, CLEANING & FILTRATION

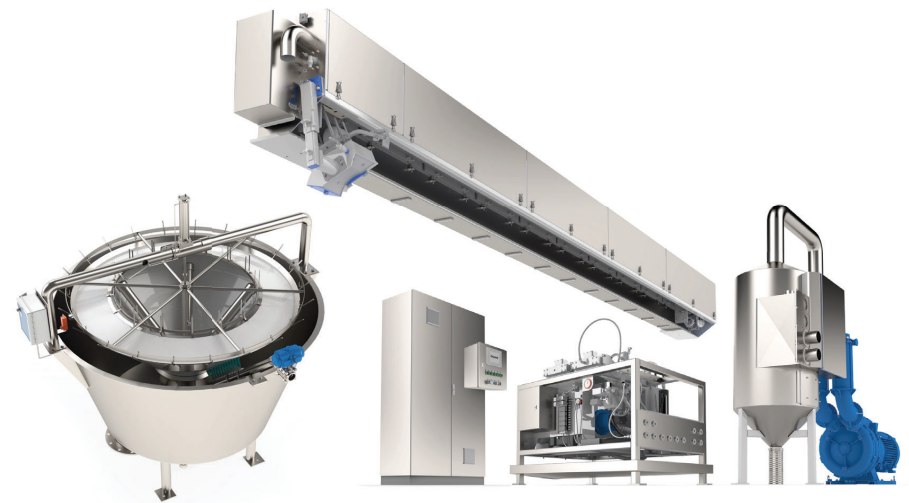

Flow Control

KEY ATTRIBUTES



Highly diversified end markets



Strong aftermarket component to business



Geographic expansion opportunities with latest business additions



Secular market drivers highly favorable for sustainable growth

Flow Control

MARKET TRENDS

Favorable market trends driving demand growth and multiple value creation levers provide a compelling story for Kadant.

GLOBAL FLOW CONTROL MARKET

(USD in billions)

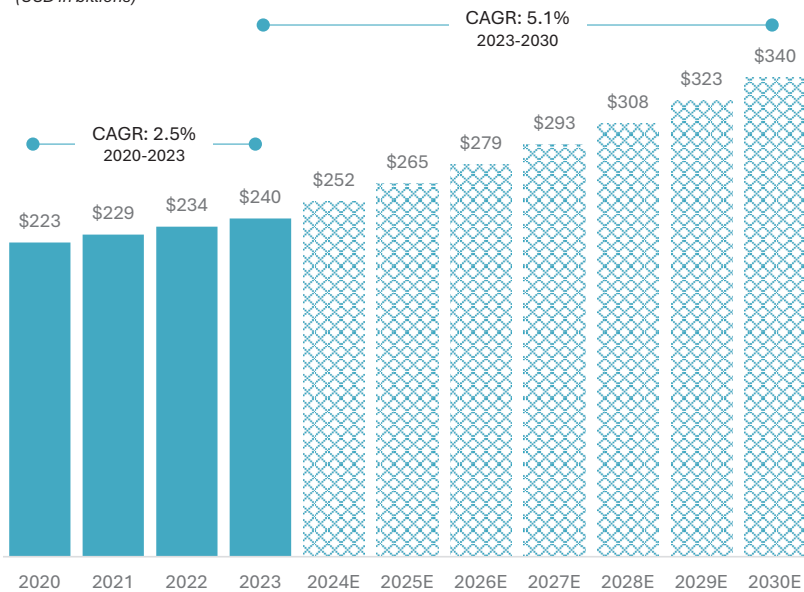

Source: McKinsey & Company, *Flow Control*, April 2019; Harris Williams, *Flow Control*, September 2024; Kadant analysis.



Decarbonization and electrification leading to increased demand for energy-optimized systems and new technologies utilizing green energy.



Disruptive technologies enabling new applications by increasing adoption of automation, advanced robotics, artificial intelligence, and rapidly expanding connectivity within process industries.



Population growth and demographic shifts create new opportunities compounded by labor shortages, aging workforce, and skills gaps.



Urbanization and aging infrastructure stimulating demand for convenience goods and services; recycling and waste management; and investments in infrastructure.



Sustainability and environmental responsibility fueling demand for increased use of recyclable (cellulose) materials to preserve and secure Earth's natural resources.

Fluid Handling Product Line

FLOW CONTROL



WES MARTZ

Vice President, Flow Control Americas

KADANT

Primary Product Offerings

FLOW CONTROL • FLUID HANDLING

STANDARD ROTARY JOINTS



CUSTOM ROTARY UNIONS

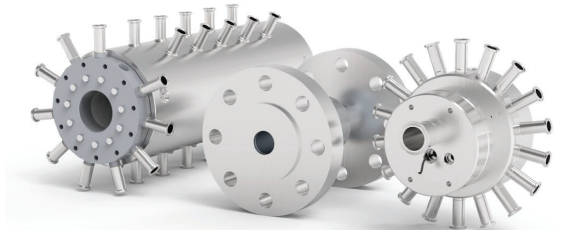

PRECISION ROTARY UNIONS

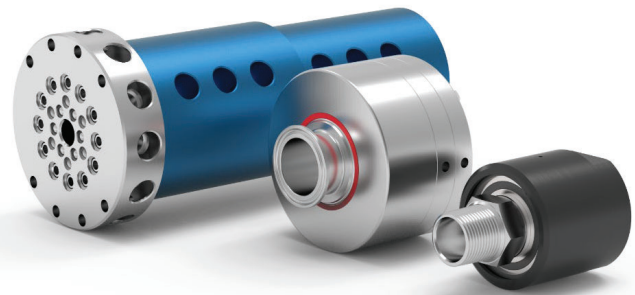

A rotary union provides the critical connection between rotating and stationary devices to allow heat transfer fluids, power, and data to flow between the two elements.

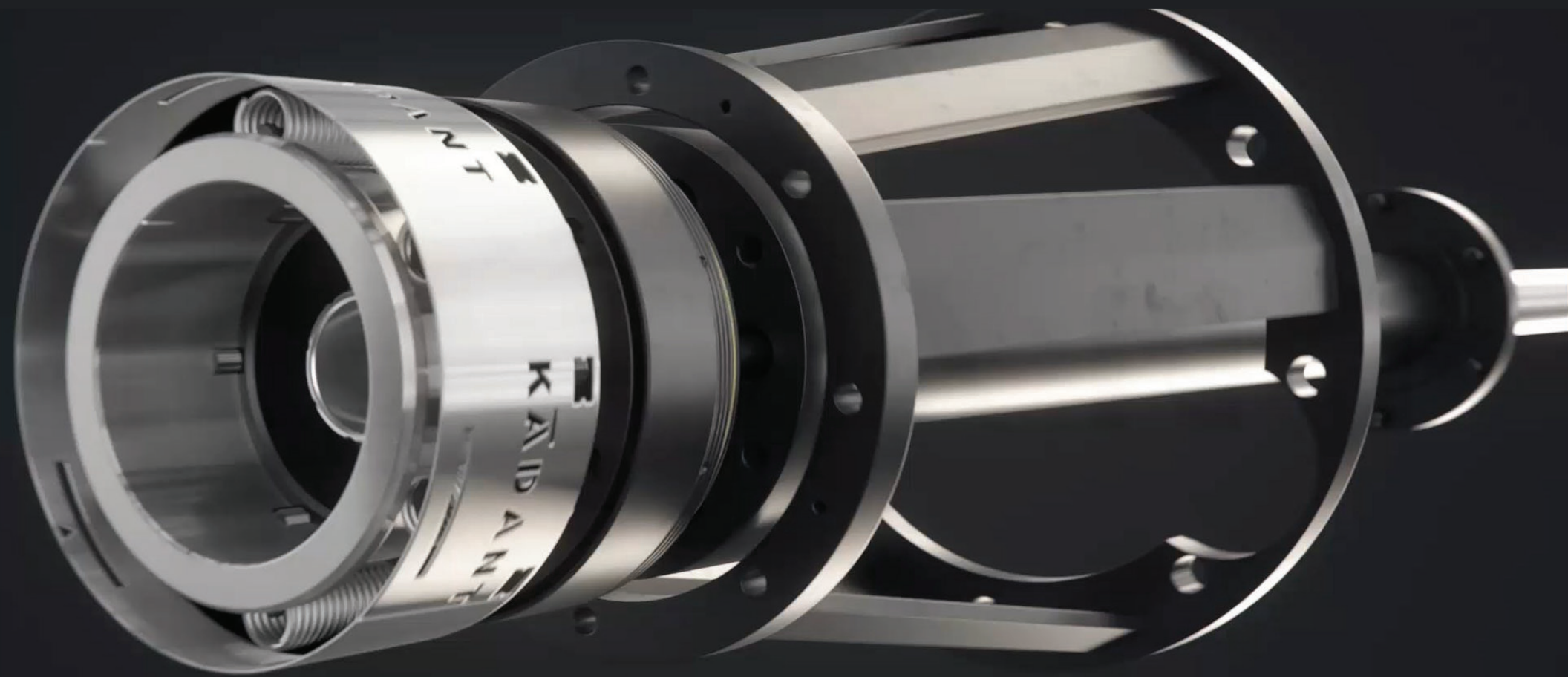

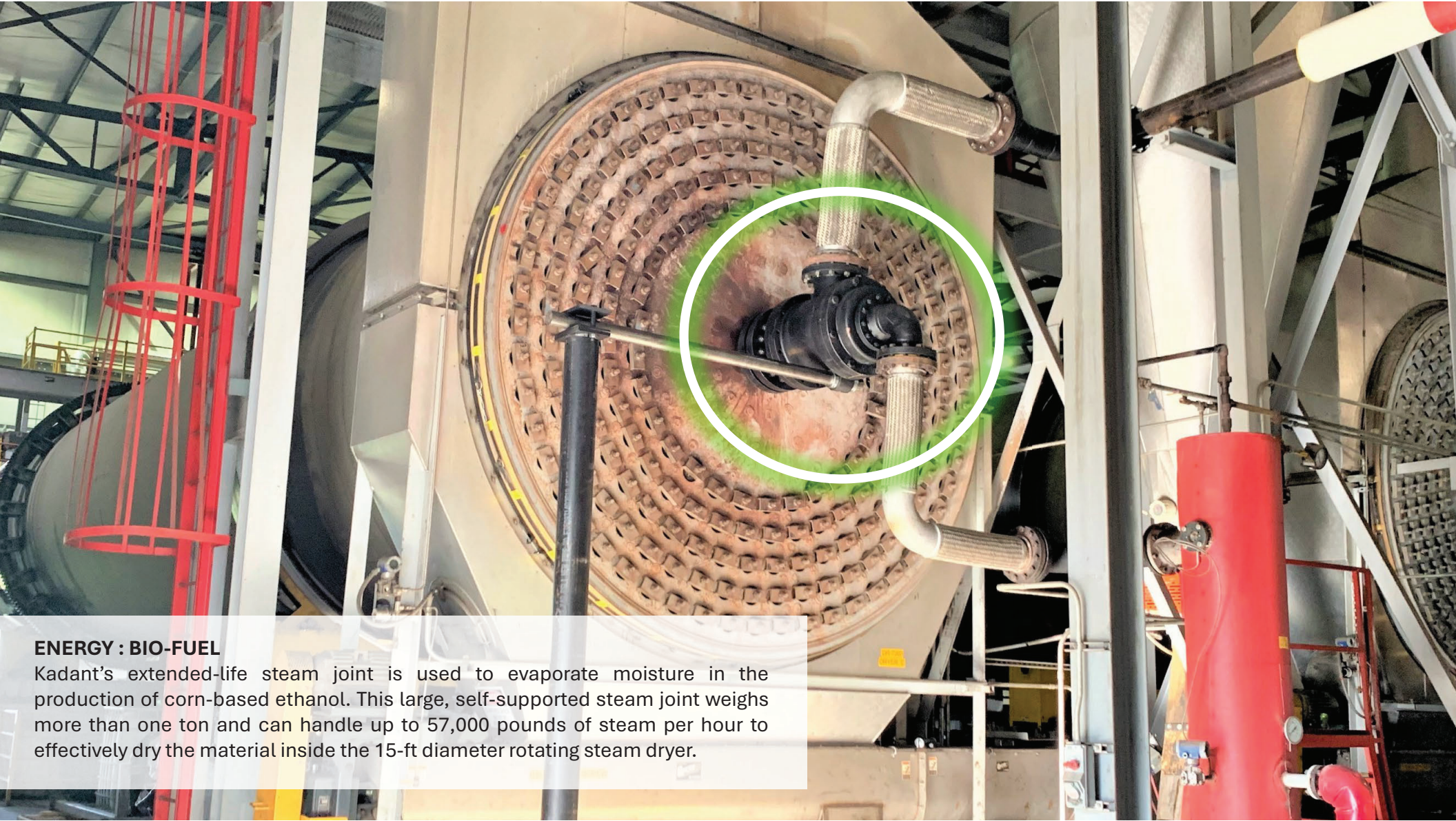

ENERGY : BIO-FUEL

Kadant's extended-life steam joint is used to evaporate moisture in the production of corn-based ethanol. This large, self-supported steam joint weighs more than one ton and can handle up to 57,000 pounds of steam per hour to effectively dry the material inside the 15-ft diameter rotating steam dryer.



FACTORY AUTOMATION : ROBOTICS

Kadant's rotary union with electrical slip ring is an integrated solution that allows the robot arm to retrieve and maneuver packages in this e-commerce fulfillment center while simultaneously reading the product and address information for proper sorting and handling.



DEFENSE : RADAR COOLING SYSTEMS

Engineered for sea, land, air, and space-based defense and surveillance radar systems, Kadant rotary joints deliver reliable cooling media to meet the challenges of modern radars such as active phased-array radars, active electronically scanned array (AESA) radars, and other radar cooling systems.



METALS : STEEL

Kadant's rotary unions are used in the steel manufacturing process to ensure rolls remain cool as steel billets are formed in the continuous casting process. With few moving parts and low maintenance requirements, Kadant's rotary union is preferred by equipment manufacturers and rebuilders worldwide.

PACKAGING, PAPER, TISSUE

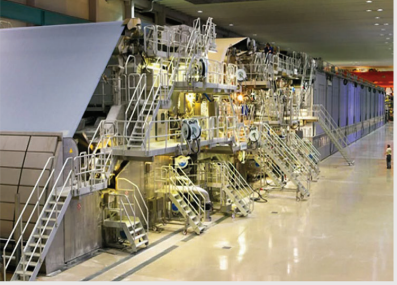

CONVERTING



ENERGY



FOOD & BEVERAGE



GENERAL INDUSTRY



DEFENSE & AEROSPACE



PLASTIC



METALS



SPECIALTY MACHINERY

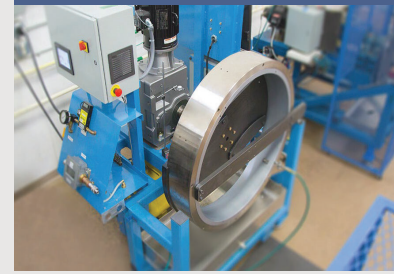

CONSTRUCTION



CHEMICAL



TEXTILE

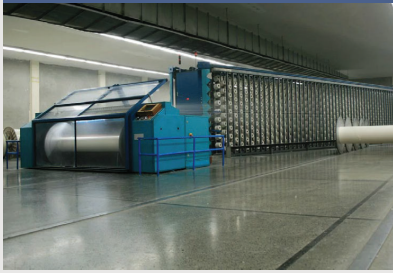

MEDICAL



FACTORY AUTOMATION

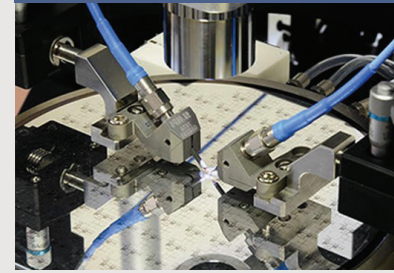

MACHINE TOOL



KADANT

Market Position and Opportunity

FLOW CONTROL • FLUID HANDLING

| INDUSTRY | KADANT POSITION ³ | SIZE ³ | GROWTH ³ | POTENTIAL |
|---------------------------|------------------------------|-------------------|---------------------|---|
| Packaging, Paper & Tissue | 1 | ★★★ | ★ | ● ● ● ○ ○ ○ ○ ○ ○ ○ ○ ○ ○ |
| Converting | 1 | ★★ | ★★ | ● ● ● ● ○ ○ ○ ○ ○ ○ ○ ○ ○ ○ |
| Energy | 2 | ★★★ | ★★★★ | ● ● ● ● ● ● ● ● ● ● ● ● ● ● |
| Food & Beverage | 1 | ★★ | ★★ | ● ● ● ● ○ ○ ○ ○ ○ ○ ○ ○ ○ ○ |
| Defense & Aerospace | 1 | ★★ | ★★★★ | ● ● ● ● ● ● ● ○ ○ ○ ○ ○ ○ ○ ○ |
| Plastic | 2 | ★★ | ★ | ● ● ○ ○ ○ ○ ○ ○ ○ ○ ○ ○ ○ ○ ○ ○ |
| Metals & Mining | 1 | ★★ | ★ | ● ● ○ ○ ○ ○ ○ ○ ○ ○ ○ ○ ○ ○ ○ ○ |
| Specialty Machinery | - | ★★★ | ★★ | ● ● ● ● ● ● ● ○ ○ ○ ○ ○ ○ ○ ○ |
| Construction | - | ★★★ | ★★★★ | ● ● ● ● ● ● ● ● ● ● ● ● ● ● ● ● ● ● |
| Chemical | 1 | ★★ | ★ | ● ● ○ ○ ○ ○ ○ ○ ○ ○ ○ ○ ○ ○ ○ ○ |
| Textile | 1 | ★ | ★ | ● ○ ○ ○ ○ ○ ○ ○ ○ ○ ○ ○ ○ ○ ○ ○ ○ ○ ○ |
| Machine Tool | 2 | ★★ | ★★ | ● ● ● ● ○ ○ ○ ○ ○ ○ ○ ○ ○ ○ ○ ○ ○ ○ |
| Medical | - | ★ | ★★ | ● ● ○ ○ ○ ○ ○ ○ ○ ○ ○ ○ ○ ○ ○ ○ ○ ○ ○ ○ |
| Factory Automation | - | ★★★ | ★★★★ | ● ● ● ● ● ● ● ● ● ● ● ● ● ● ● ● ● ● |

A global leader in fluid sealing with diversified end-market exposure.

Market Position and Opportunity

FLOW CONTROL • FLUID HANDLING

| INDUSTRY | KADANT POSITION ³ | SIZE ³ | GROWTH ³ | POTENTIAL |
|--------------------------------|------------------------------|-------------------|---------------------|-------------------------|
| Packaging, Paper & Tissue | 1 | ★★★ | ★ | ● ● ● ○ ○ ○ ○ ○ ○ ○ ○ |
| Converting | 1 | ★★ | ★★ | ● ● ● ● ○ ○ ○ ○ ○ ○ ○ ○ |
| Energy | 2 | ★★★ | ★★★★ | ● ● ● ● ● ● ● ● ● ● |
| Food & Beverage | 1 | ★★ | ★★ | ● ● ● ● ○ ○ ○ ○ ○ ○ ○ ○ |
| Defense & Aerospace | 1 | ★★ | ★★★★ | ● ● ● ● ● ● ○ ○ ○ ○ ○ ○ |
| Plastic | 2 | ★★ | ★ | ● ● ○ ○ ○ ○ ○ ○ ○ ○ ○ ○ |
| Metals & Mining | 1 | ★★ | ★ | ● ● ○ ○ ○ ○ ○ ○ ○ ○ ○ ○ |
| Specialty Machinery | - | ★★★ | ★★ | ● ● ● ● ● ● ○ ○ ○ ○ ○ ○ |
| Construction | - | ★★★ | ★★★★ | ● ● ● ● ● ● ● ● ● ● ● ● |
| Chemical | 1 | ★★ | ★ | ● ● ○ ○ ○ ○ ○ ○ ○ ○ ○ ○ |
| Textile | 1 | ★ | ★ | ● ○ ○ ○ ○ ○ ○ ○ ○ ○ ○ ○ |
| Machine Tool | 2 | ★★ | ★★ | ● ● ● ● ○ ○ ○ ○ ○ ○ ○ ○ |
| Medical | - | ★ | ★★ | ● ● ○ ○ ○ ○ ○ ○ ○ ○ ○ ○ |
| Factory Automation | - | ★★★ | ★★★★ | ● ● ● ● ● ● ● ● ● ● ● ● |

A global leader in fluid sealing with diversified end-market exposure.

Innovation

FLOW CONTROL • FLUID HANDLING

MEDICAL

Image-guided Radiation Therapy

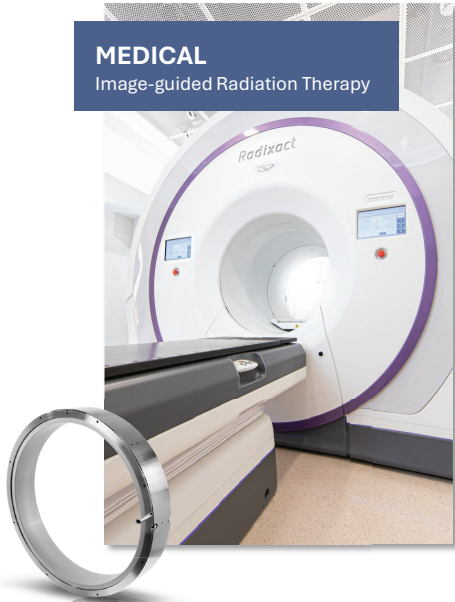

- Low torque, high-reliability
- Designed to acuate beam shape
- Highly targeted radiation delivery

DEFENSE

Mine Roller

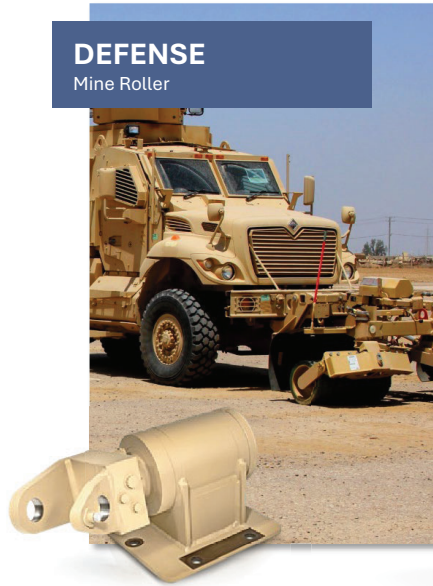

- High vibration and shock
- Load bearing, mounting flexibility
- Increased safety and accuracy

FACTORY AUTOMATION

End of Arm Tool



- Simplify robot vision system
- Load bearing + minimal weight
- Power and data transfer

PACKAGING

Corrugated Box Plant

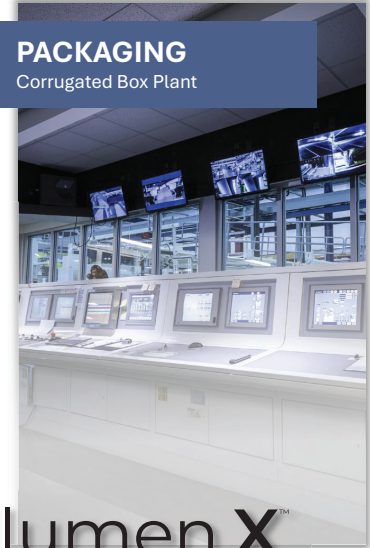

illumene.X[™]
digital platform

- Alert system + remote monitoring
- Simplified operator interface
- Integrated control systems

Innovation

FLOW CONTROL • FLUID HANDLING

MEDICAL Image-guided Radiation Therapy

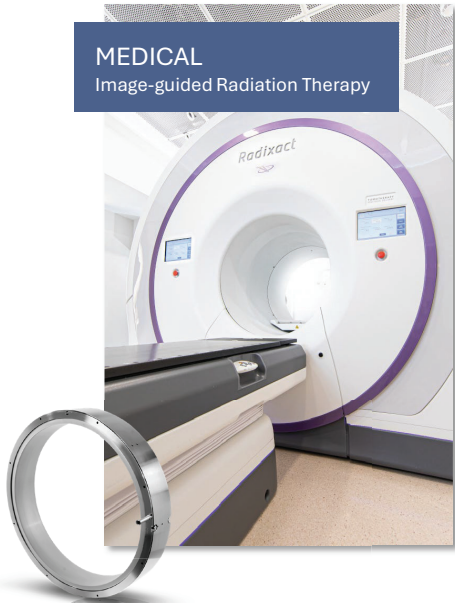

- Low torque, high-reliability
- Designed to acuate beam shape
- Highly targeted radiation delivery

DEFENSE Mine Roller

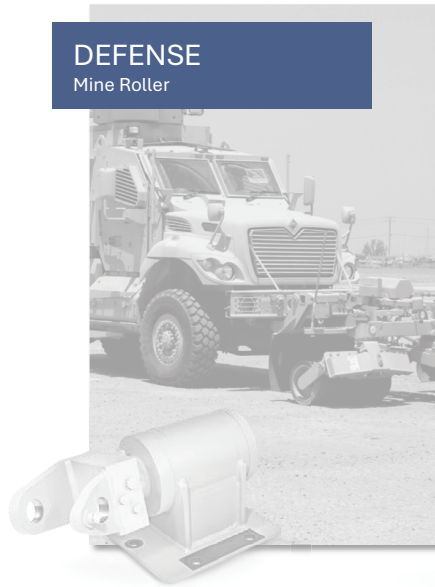

- High vibration and shock
- Load bearing, mounting flexibility
- Increased safety and accuracy

FACTORY AUTOMATION End of Arm Tool

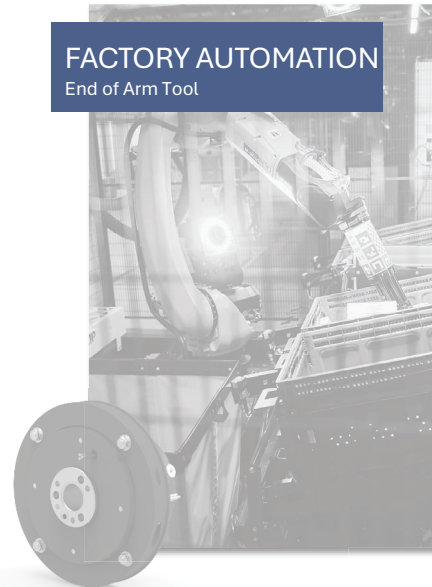

- Simplify robot vision system
- Load bearing + minimal weight
- Power and data transfer

PACKAGING Corrugated Box Plant

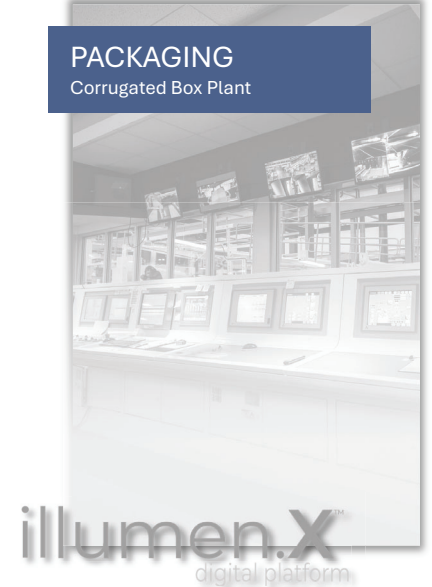

illumen.X
digital platform

- Alert system + remote monitoring
- Simplified operator interface
- Integrated control systems

Innovation

FLOW CONTROL • FLUID HANDLING

MEDICAL
Image-guided Radiation Therapy

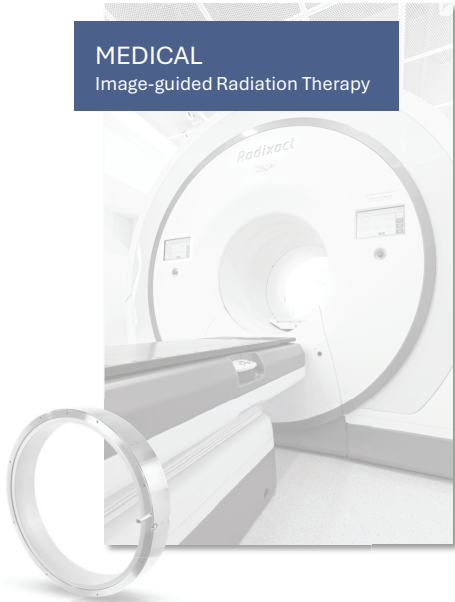

- Low torque, high-reliability
- Designed to acuate beam shape
- Highly targeted radiation delivery

DEFENSE
Mine Roller

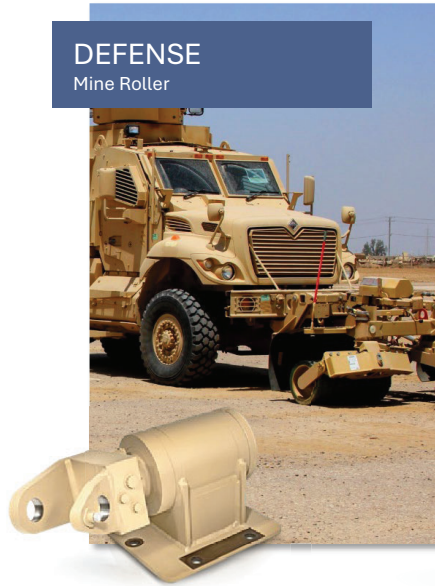

- High vibration and shock
- Load bearing, mounting flexibility
- Increased safety and accuracy

FACTORY AUTOMATION
End of Arm Tool

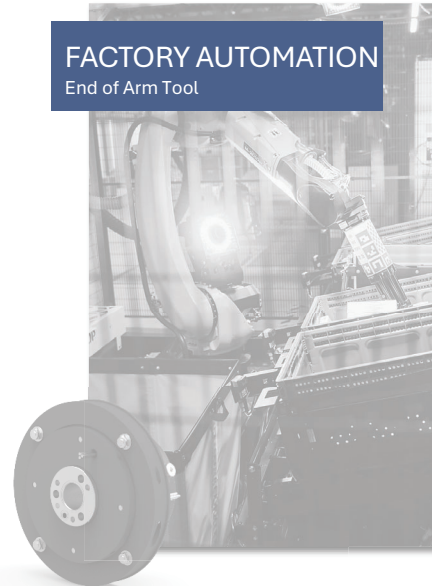

- Simplify robot vision system
- Load bearing + minimal weight
- Power and data transfer

PACKAGING
Corrugated Box Plant

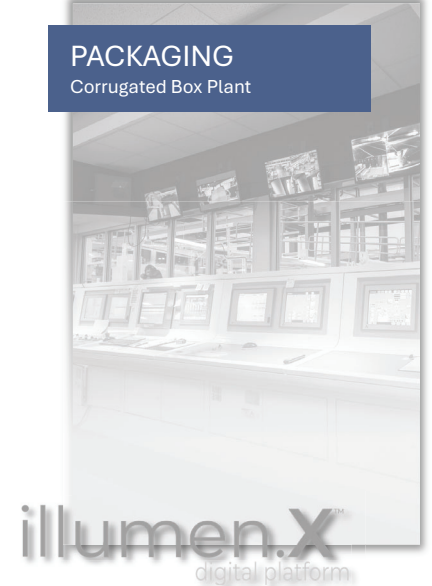

illumene.X
digital platform

- Alert system + remote monitoring
- Simplified operator interface
- Integrated control systems

Innovation

FLOW CONTROL • FLUID HANDLING

MEDICAL Image-guided Radiation Therapy

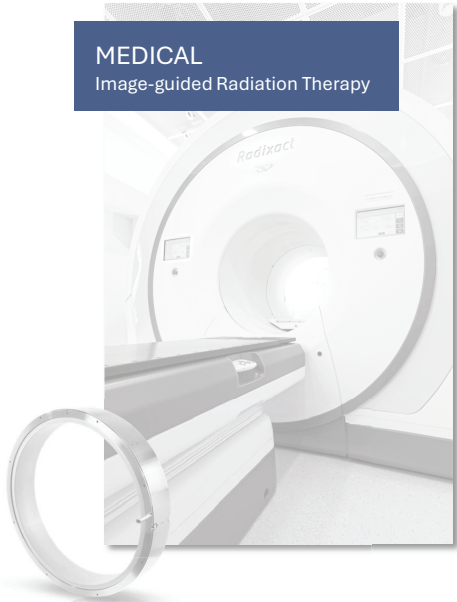

- Low torque, high-reliability
- Designed to acuate beam shape
- Highly targeted radiation delivery

DEFENSE Mine Roller

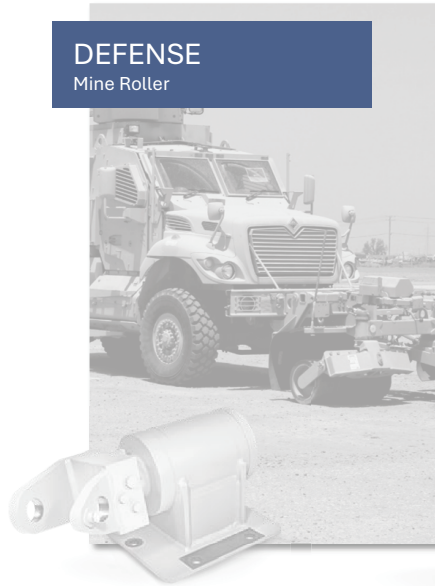

- High vibration and shock
- Load bearing, mounting flexibility
- Increased safety and accuracy

FACTORY AUTOMATION End of Arm Tool



- Simplify robot vision system
- Load bearing + minimal weight
- Power and data transfer

PACKAGING Corrugated Box Plant

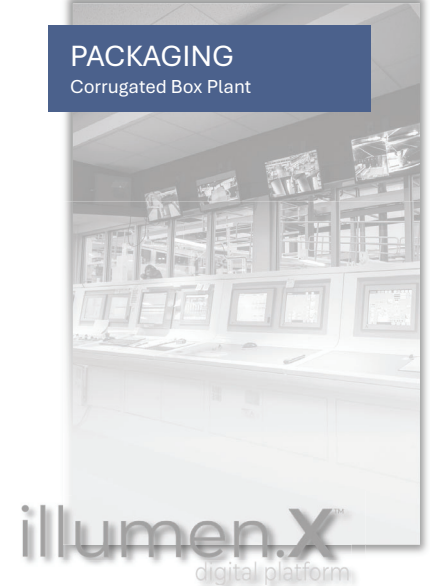

- Alert system + remote monitoring
- Simplified operator interface
- Integrated control systems

Innovation

FLOW CONTROL • FLUID HANDLING

MEDICAL
Image-guided Radiation Therapy

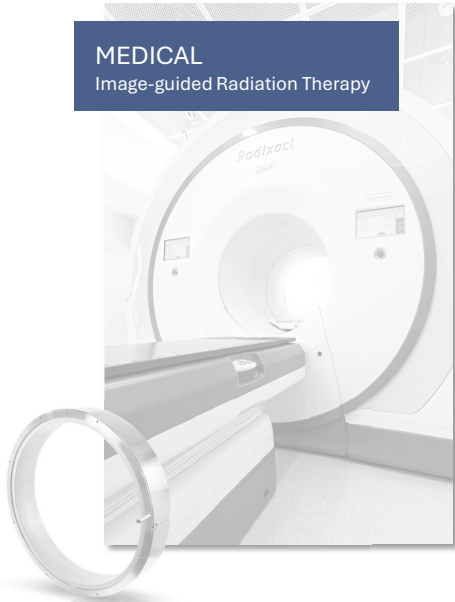

- Low torque, high-reliability
- Designed to acuate beam shape
- Highly targeted radiation delivery

DEFENSE
Mine Roller

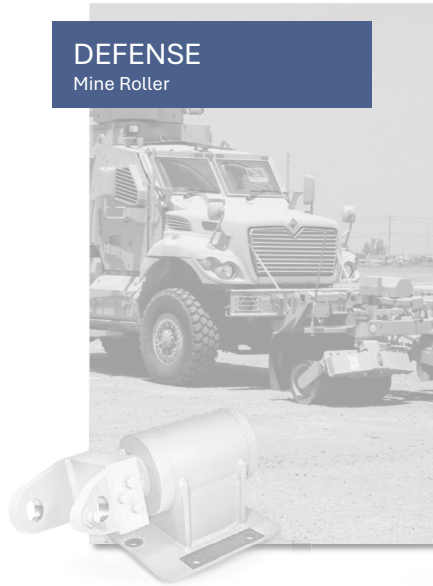

- High vibration and shock
- Load bearing, mounting flexibility
- Increased safety and accuracy

FACTORY AUTOMATION
End of Arm Tool

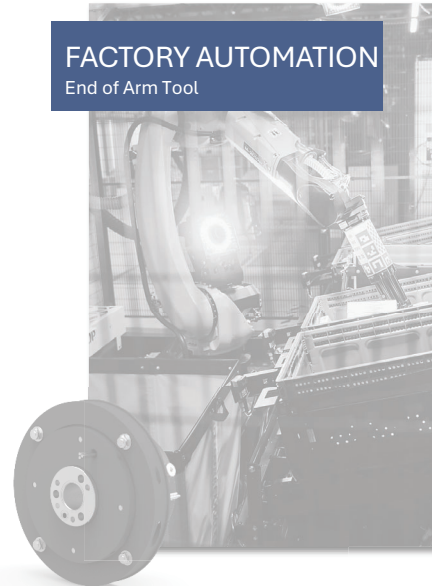

- Simplify robot vision system
- Load bearing + minimal weight
- Power and data transfer

PACKAGING
Corrugated Box Plant

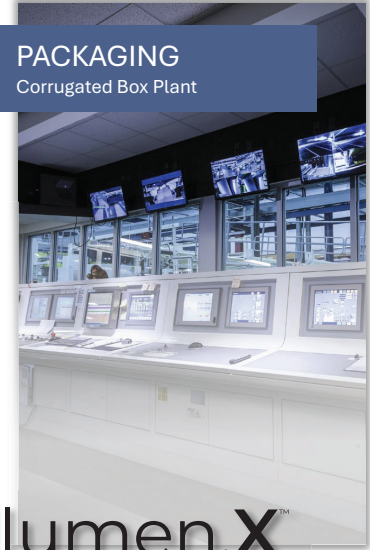

illumen.X
digital platform

- Alert system + remote monitoring
- Simplified operator interface
- Integrated control systems

Doctoring, Cleaning & Filtration Product Line

FLOW CONTROL



BILAL MEHMOOD

President, Kadant Solutions

KĀDANT

Primary Product Offerings

FLOW CONTROL • DOCTORING, CLEANING & FILTRATION

DOCTORING



Increased machine efficiency and product quality

Water removal, roll cleaning, and scraping products to maximize productivity and machine uptime.

CLEANING

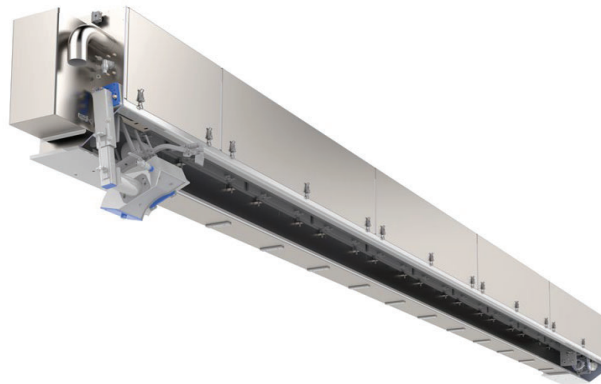

Water and energy reduction

Fabric and belt cleaning products to improve product quality, runnability, and optimize energy utilization.

FILTRATION



Reduction of water resources and energy savings

Filtration products to recover fiber, reduce water consumption, and improve energy efficiency.

Key End Markets

FLOW CONTROL • DOCTORING, CLEANING & FILTRATION

PACKAGING,
PAPER & TISSUE



BUILDING
MATERIALS



METALS



FOOD



ENERGY



SYNTHETIC/
CARBON FIBER

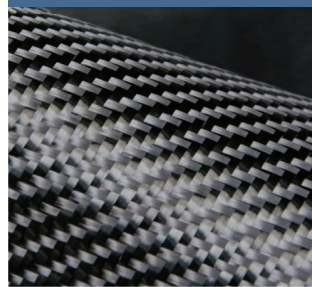

NON-WOVENS

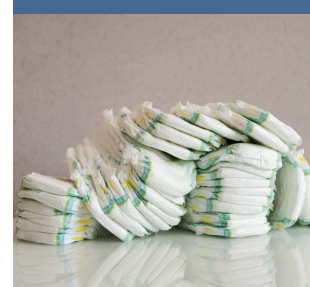

CONVERTING

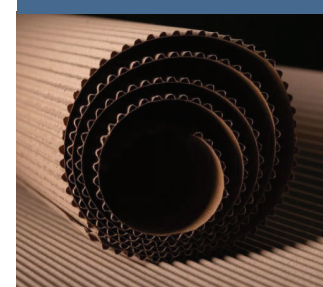

Market Position and Opportunity

FLOW CONTROL • DOCTORING, CLEANING & FILTRATION

| INDUSTRY | KADANT POSITION ³ | SIZE ³ | GROWTH ³ | POTENTIAL |
|-----------------------------------|------------------------------|-------------------|---------------------|---------------------|
| Packaging, Paper & Tissue | 1 | ★★★ | ★★ | ● ● ● ● ● ● ○ ○ ○ |
| Construction (Building Materials) | 2 | ★★ | ★★ | ● ● ● ● ○ ○ ○ ○ ○ |
| Food | 1 | ★★★ | ★★★★ | ● ● ● ● ● ● ● ● ● ● |
| Metals | 2 | ★★ | ★★ | ● ● ● ● ○ ○ ○ ○ ○ |
| Energy | 1 | ★★★ | ★★★★ | ● ● ● ● ● ● ● ● ● ● |
| Converting | - | ★★ | ★ | ● ● ○ ○ ○ ○ ○ ○ ○ ○ |
| Synthetic/Carbon Fiber | 1 | ★★ | ★★ | ● ● ● ● ○ ○ ○ ○ ○ |
| Nonwovens | 2 | ★★ | ★ | ● ● ○ ○ ○ ○ ○ ○ ○ ○ |
| Chemical | - | ★★ | ★ | ● ● ○ ○ ○ ○ ○ ○ ○ ○ |
| Factory Automation | - | ★★★ | ★★★★ | ● ● ● ● ● ● ● ● ● ● |

A global leader in doctoring, cleaning & filtration with diversified end-market exposure.

KĀDANT

35_m 26_s

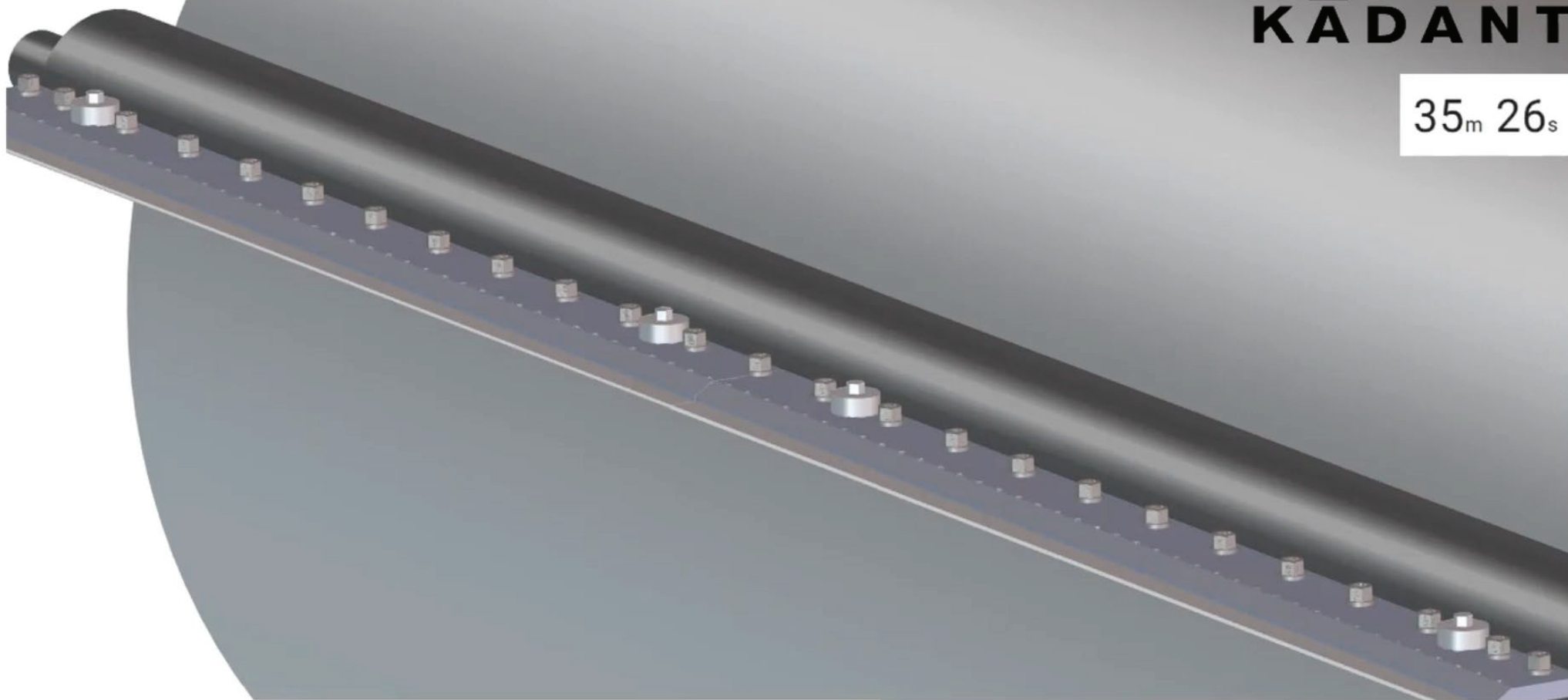

Key Market: Tissue & Hygiene Products

FLOW CONTROL • DOCTORING, CLEANING & FILTRATION

End Use

- Bath and facial tissue, kitchen napkin and towel
- Home and hospitality/commercial grades

Kadant Products: Patented, proprietary Conformatric™ creping holders and ProCrepe® bi-metal and CeraEdge™ ceramic blade technology. Our proprietary, patented technology has become the industry standard for high-quality production

ROI/Payback

- Improved uptime and runnability
- Consistent, high-quality production
- Up to \$1 million in production savings annually from reduced downtime due to blade changes

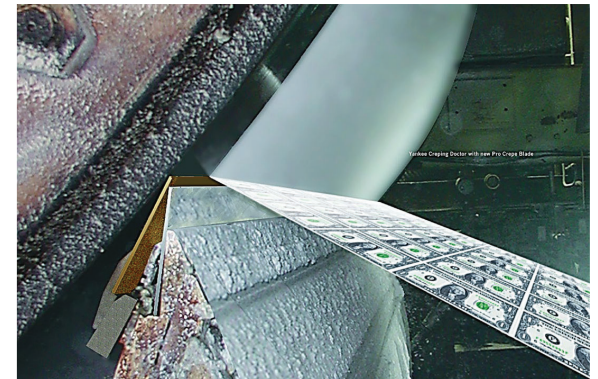
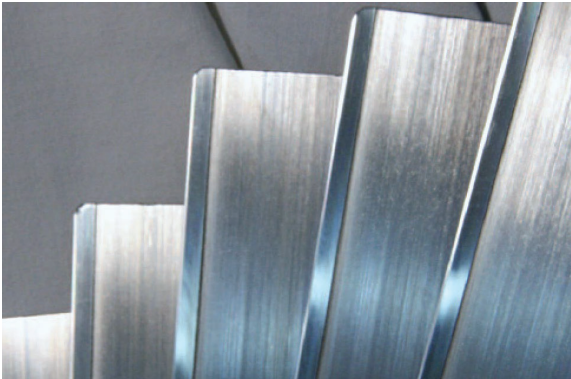

Key Market: Food

FLOW CONTROL • DOCTORING, CLEANING & FILTRATION

End Use: Crackers/Cookies, Chocolate Bars, Snack/Breakfast Bars, Food Ingredients, Starches, Yeasts, Potato Flakes, Cereal

Kadant Products: Proprietary Accuflake™ Holder, Proflake™ Blades for roll cleaning systems

ROI/Payback:

- Increased production 12% by modifying an OEM-supplied machine
- Our holder and roll-cleaning equipment increased blade life 5-7 days
- Quality improved addressing contaminants, burnt product, and wet pieces

HACCP International-certified products

- Cleaning devices: improve product quality and increase throughput while ensuring food safety requirements are met
- Holders and blades: reduce downtime associated with blade changes to increase production

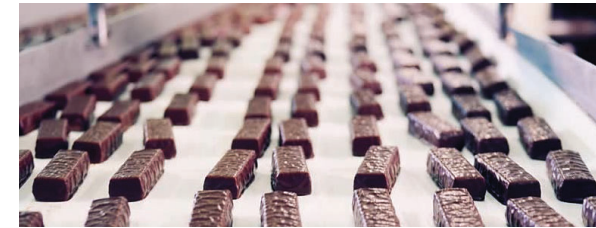

Key Market: Nonwovens

FLOW CONTROL • DOCTORING, CLEANING & FILTRATION

End Use: Fiberglass Mat, Wipes, Hygiene Products, Filters, Geo-Textiles, Insulation, Grocery bags

Kadant Product: M-Clean™ Cleaning & Conditioning System

ROI/Payback: Sustainability Goals

- Reduce water usage by 95% over current methods
- Reduced maintenance of key process equipment by 4x
- Water reuse
- Fiber recovery



Key Market: Nonwovens

FLOW CONTROL • DOCTORING, CLEANING & FILTRATION

M Clean™ Cleaning and Conditioning System enables our customers to benefit from water reuse and fiber recovery.

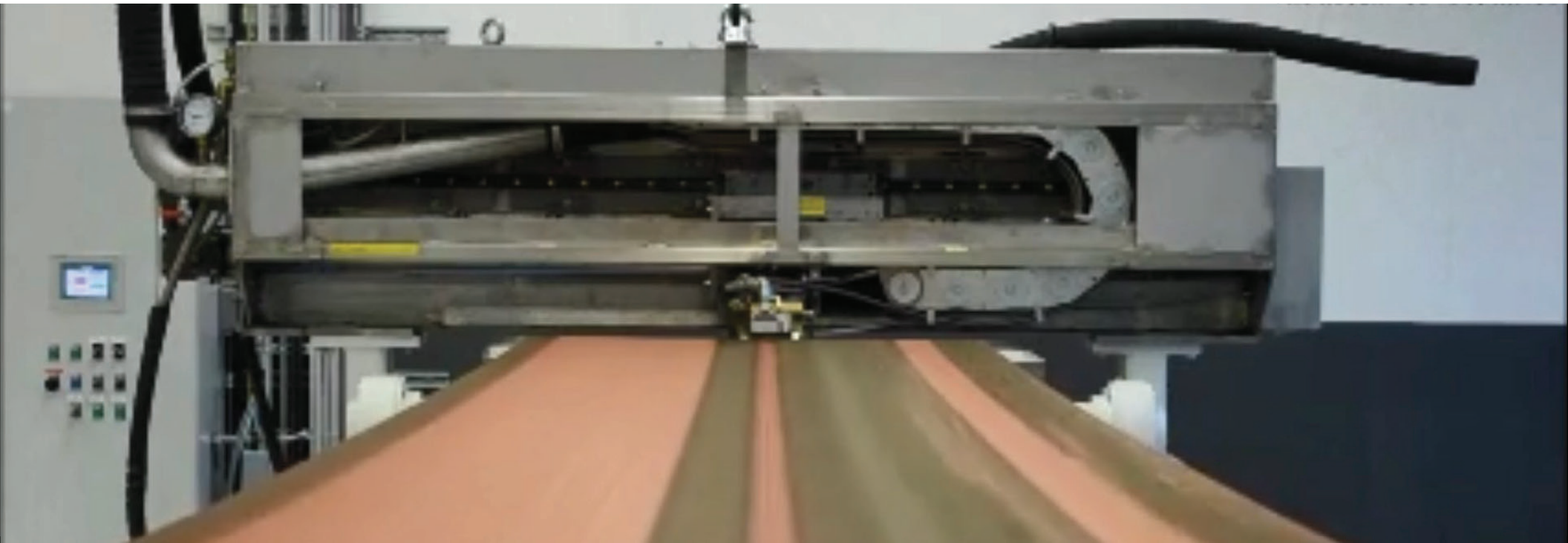

Key Market: Nonwovens

FLOW CONTROL • DOCTORING, CLEANING & FILTRATION

End Use: Fiberglass Mat, Wipes, Hygiene Products, Filters, Geo-Textiles, Insulation, Grocery bags

Kadant Product: M-Clean™ Cleaning & Conditioning System

ROI/Payback: Sustainability Goals

- Reduce water usage by 95% over current methods
- Reduced maintenance of key process equipment by 4x
- Water reuse
- Fiber recovery



Key Market: Molded Fiber

FLOW CONTROL • DOCTORING, CLEANING & FILTRATION

End Use: Food Containers, Packaging

Kadant Products: Filtration Systems

ROI/Payback: Sustainability Goals - Reuse process water to enhance machine operation and increase fiber recovery



Our products filter 1.2 billion gallons of water per day, saving approximately \$569 million per year in heating energy.

Innovation

FLOW CONTROL • DOCTORING, CLEANING & FILTRATION

The kConnect™ series is a group of smart-connected products and services designed to provide access to real-time metrics important for inventory management and machine performance.



Flow Control

KEY TAKEAWAYS



Highly diversified end markets



Secular market drivers highly favorable for sustainable growth



Geographic expansion opportunities with latest business additions



Strong aftermarket component to business

MATERIAL HANDLING

Driving sustainability through recycling solutions for industries and communities.



CHAD GREENFIELD

Commercial Director, Syntron Material Handling

KADANT

Material Handling

KEY ATTRIBUTES



Infrastructure-critical end markets



Continuous growth through industry expansion



Resource sustainability initiatives provide strong growth



Strong global market share



Strong aftermarket component to business

Material Handling

MARKET TRENDS

Favorable market trends driving demand growth and multiple value-creation levers provide a compelling story for Kadant.

GLOBAL MATERIAL HANDLING MARKET

(USD in billions)

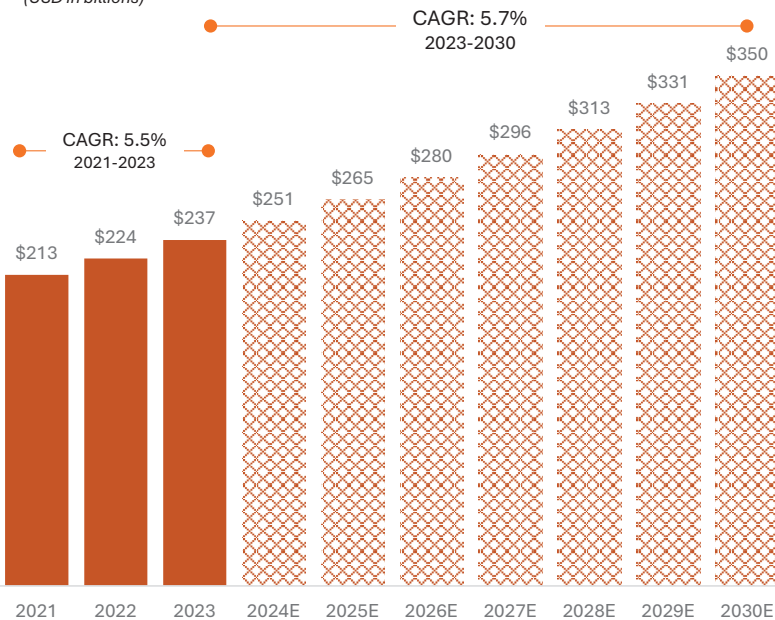

Source: Grandview Research, *Material Handling Equipment*, 2022; Kadant analysis.



Decarbonization and electrification leading to increased demand for energy-optimized systems and new technologies utilizing green energy.



Disruptive technologies enabling new applications by increasing adoption of automation, advanced robotics, artificial intelligence, and rapidly expanding connectivity within process industries.



Population growth and demographic shifts create new opportunities compounded by labor shortages, aging workforce, and skills gaps.



Urbanization and aging infrastructure stimulating demand for convenience goods and services; recycling and waste management; and investments in infrastructure.



Sustainability and environmental responsibility fueling demand for increased use of recyclable (cellulose) materials to preserve and secure Earth's natural resources.

Material Handling

PRODUCT LINES

CONVEYING AND VIBRATORY FEEDING



BALERS



Conveying & Vibratory Feeding Product Line

MATERIAL HANDLING



CHAD GREENFIELD

Commercial Director, Syntron Material Handling

KĀDANT



Markets and Applications

MATERIAL HANDLING • CONVEYING & VIBRATORY FEEDING



Primary Product Offerings

MATERIAL HANDLING • CONVEYING & VIBRATORY FEEDING

CONVEYING



SCREENING



VIBRATORY FEEDING





Three Major Conveying Products: Conveyor Idlers, Conveyor Belt Trackers, and Screw Conveyors

- Established industry leader since 1880
- Trusted global partner to leading producers
- 24/7 real-time monitoring makes operations safer and more efficient



Screening Products

- Applications in numerous industries, including heavy minerals, food processing, and pharmaceuticals
- Screens are critical path equipment required for end users to operate
- Wireless monitoring allows users to observe machine health and analyze data in real-time

Vibrating Screen

Vibratory Feeder Products: Electromagnetic & Electromechanical

- Industry leader that pioneered vibratory feeding technology almost 100 years ago
- Highly-engineered products that increase productivity and improve cost-per-ton handling efficiency
- Equipped with wireless Asset Performance Monitoring

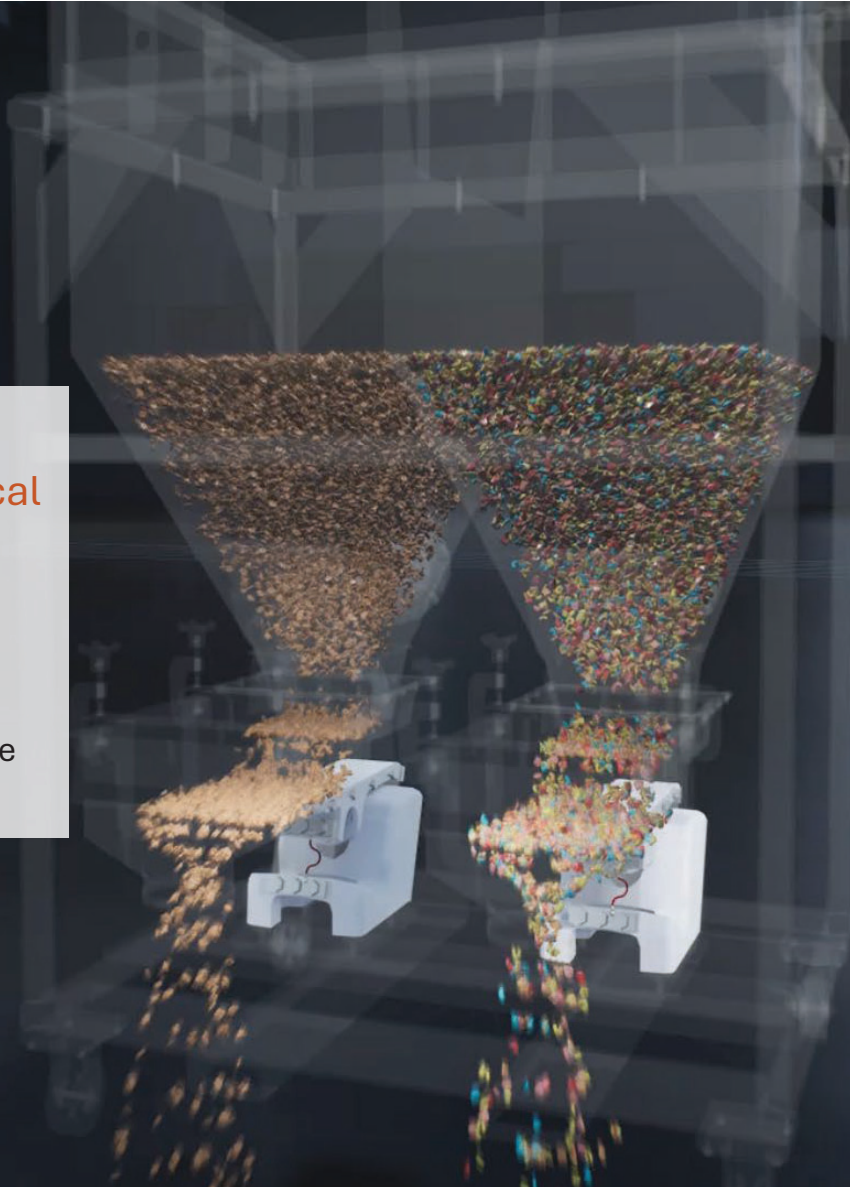

BF-3 w/ Hopper

Innovation

MATERIAL HANDLING • CONVEYING & VIBRATORY FEEDING

Automation: Asset Performance Monitoring

- 24/7 wireless monitoring sensor system collects and analyzes data in real-time on vibratory feeders and screens
- Provide alerts for operational anomalies and potential failures
- Users see increased production and decreased unplanned downtime



Innovation

MATERIAL HANDLING • CONVEYING & VIBRATORY FEEDING

Automation: Smart Idler

- 24/7 wireless monitoring alerts users of potential failures before they happen
- Provides increased efficiency, reduced downtime, and a safer operating environment

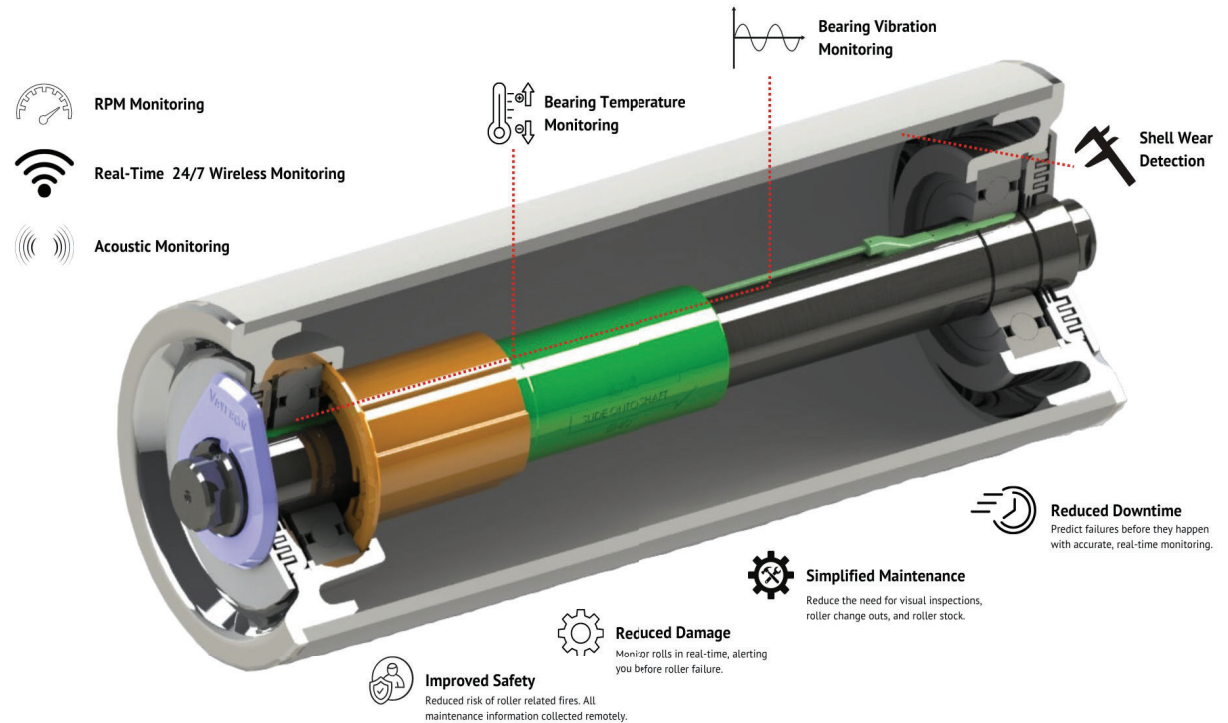

Longest Conveyor in the Western Hemisphere

MATERIAL HANDLING • CONVEYING & VIBRATORY FEEDING

Atlas Energy Solutions – Dune Express Project

- Longest overland conveyor in the Americas (42 miles) and the largest built in the world in the last 45 years
- Dune Express is the most technologically advanced bulk material handling conveyor in the world
- Expected to reduce emissions and road traffic by 70%

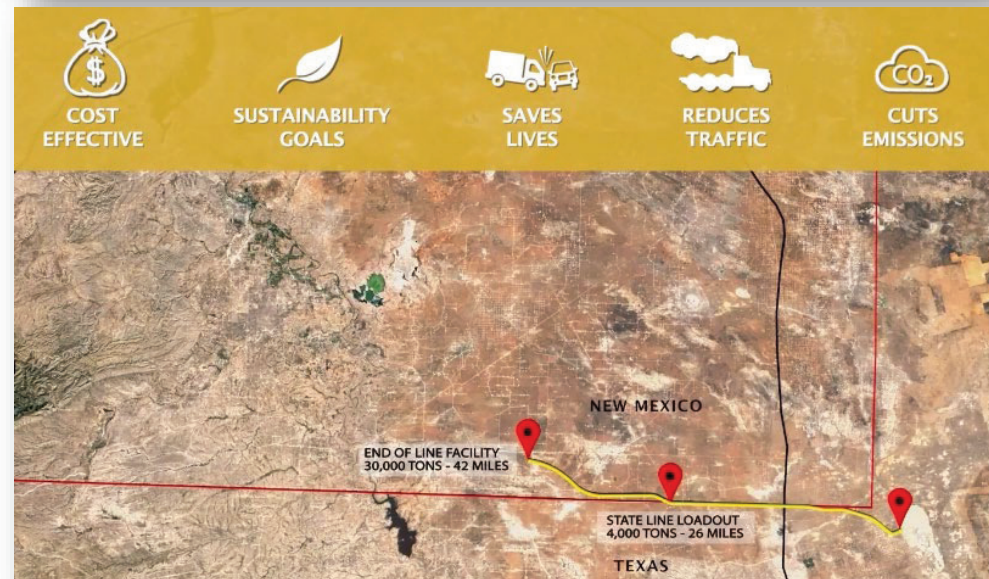



Syntron
Material Handling

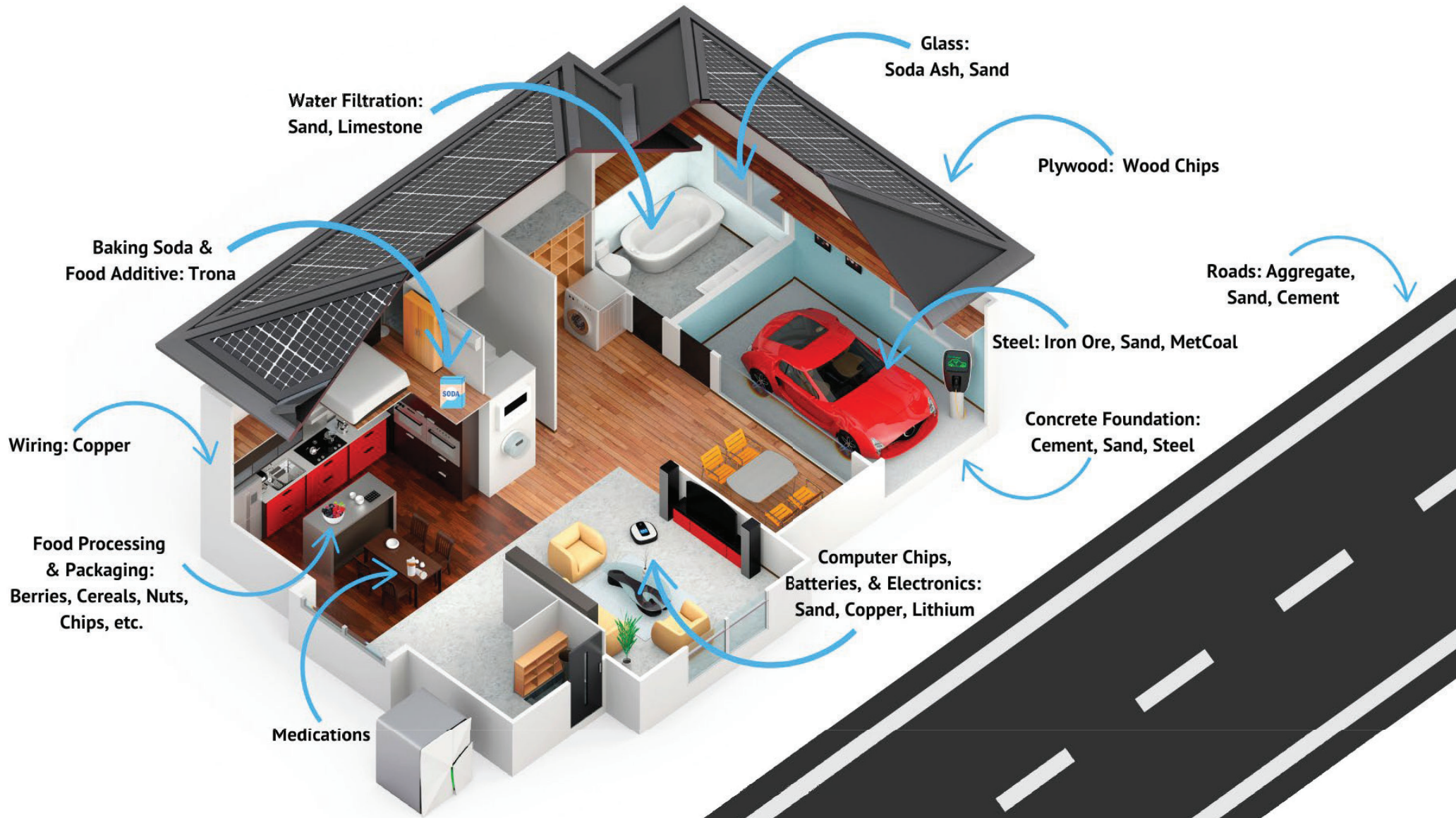

Baler Product Line

MATERIAL HANDLING



CRAIG HELEY
President, Kadant PAAL

KĀDANT

Primary Product Offerings

MATERIAL HANDLING • BALERS

Kadant offers the largest range of balers and is the best at providing customer solutions.



AUTO-TIE CHANNEL BALER

High throughput,
high efficiency



HOGGER & SHREDDER

Process boxboard to
make baling more efficient



TWIN RAM BALER

Suitable for wet waste
containing organics



PP TWINE AUTO-TIE BALER

Complete bale can
be incinerated



Key Markets

MATERIAL HANDLING • BALERS

Kadant balers are utilized in a diverse range of applications.

RECYCLERS &
WASTE MANAGEMENT



RETAIL & DISTRIBUTION



PAPER & PACKAGING



WASTE-TO-ENERGY



AGRICULTURE



MRF

AUTOMATED SORTING PLANT

Key Markets

MATERIAL HANDLING • BALERS

Kadant balers are utilized in a diverse range of applications.

RECYCLERS &
WASTE MANAGEMENT



RETAIL & DISTRIBUTION



PAPER & PACKAGING



WASTE-TO-ENERGY



AGRICULTURE



End Markets

MATERIAL HANDLING • BALERS

A single Kadant baler can process a broad range of materials.



SHREDDED PAPER



CLEAR PLASTIC



JUICE/DRINK BOX



BALE FIELD (CLEAN)



AG PRODUCTS



CARDBOARD



HARD PLASTICS



ALUMINUM



WASTE TO FUEL



WRAPPED WASTE FUEL

Automation

Reliable, repeatable quality is achieved through investment in our manufacturing process.

- Investment in large welding robots
- Largest baler manufacturer globally
- Shortest lead times in market



Innovation

BALEiD (Bale material content)

- Patented automatic application
- RFID technology
- Trace materials more accurately
- Manage logistics more effectively



Innovation

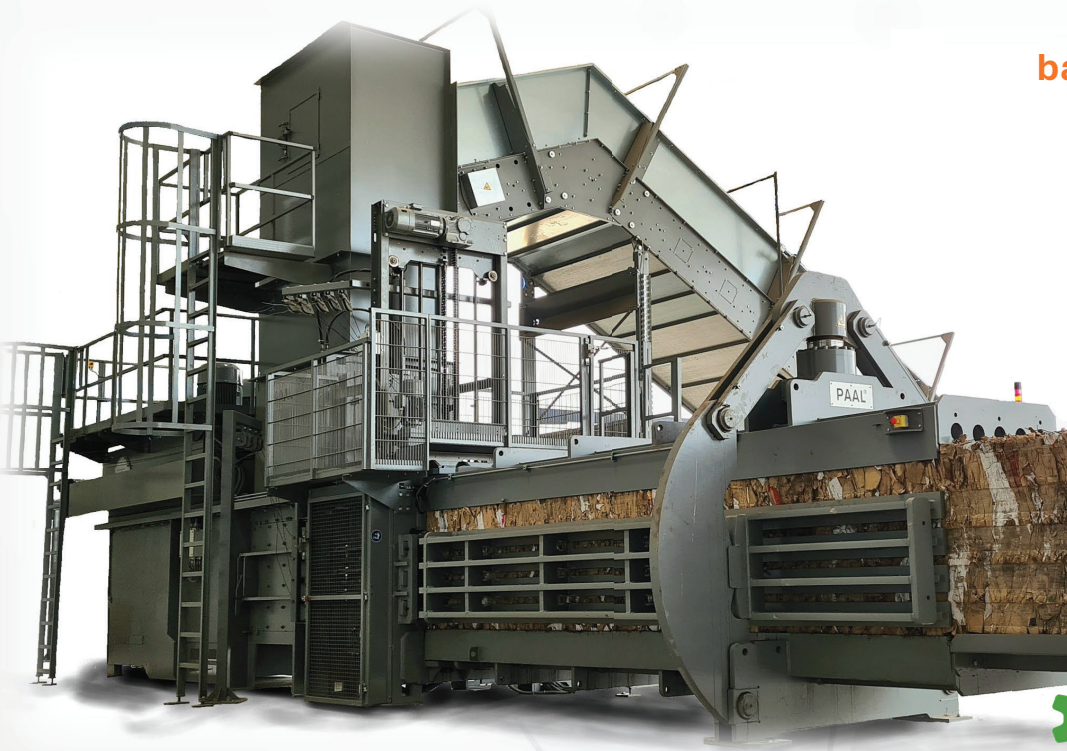

PAAL[®]
connex

Connect to
baler remotely

PAAL[®]
analytiX

Receive essential
information



PAAL[®]
prediX

Predict need to
replace parts

PAAL[®]
webshop

Find and order
spare parts

illumen.X[™]
digital platform

illumien.X Dashboard

MATERIAL HANDLING • BALERS

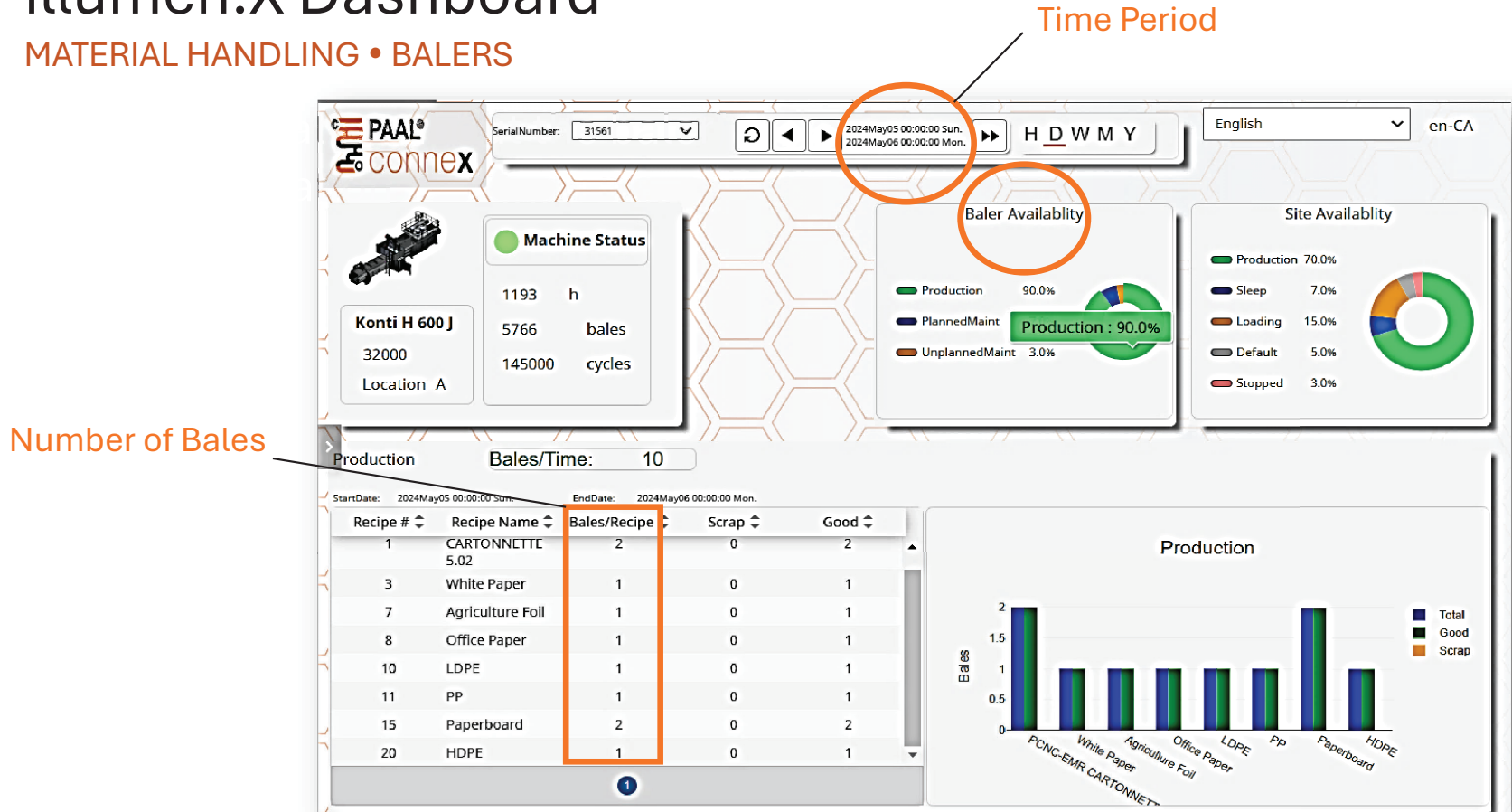

illum.X Dashboard: Work Shop and Web Shop

MATERIAL HANDLING • BALERS

Select the sub-assembly; drill down to the required part and order

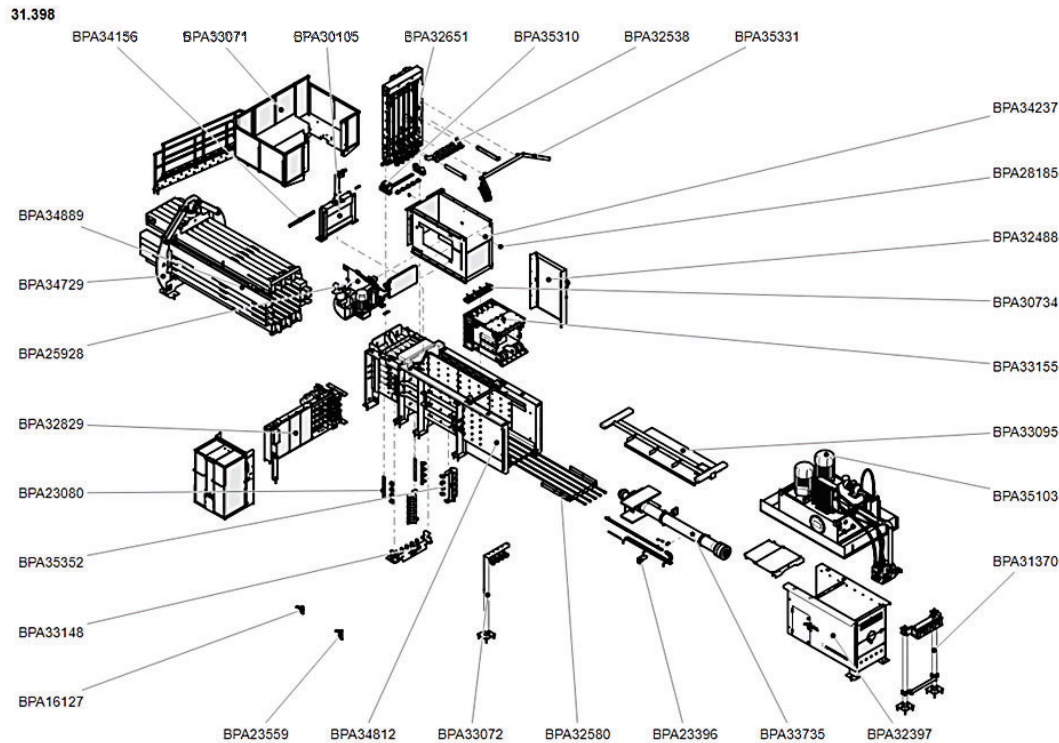

BPA32631

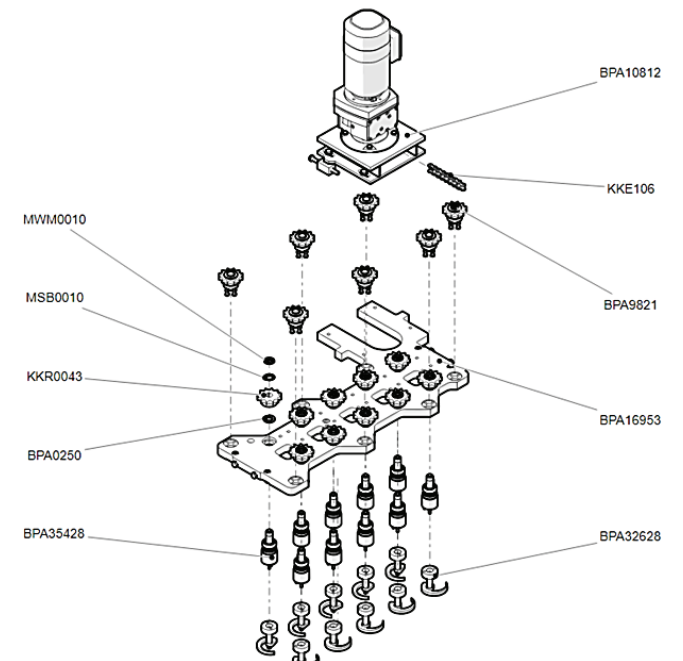

illum.X[™]
digital platform

Key Takeaways

MATERIAL HANDLING



Infrastructure-critical end markets



Continuous growth through industry expansion



Resource sustainability initiatives provide strong growth



Strong global market share



Strong aftermarket component to business

INDUSTRIAL PROCESSING

Solutions to help customers maximize the production of fiber-based, renewable products.



MICHAEL COLWELL

Senior Vice President, Industrial Processing

KADANT

Industrial Processing

PRODUCT LINES

WOOD PROCESSING



FIBER PROCESSING 4

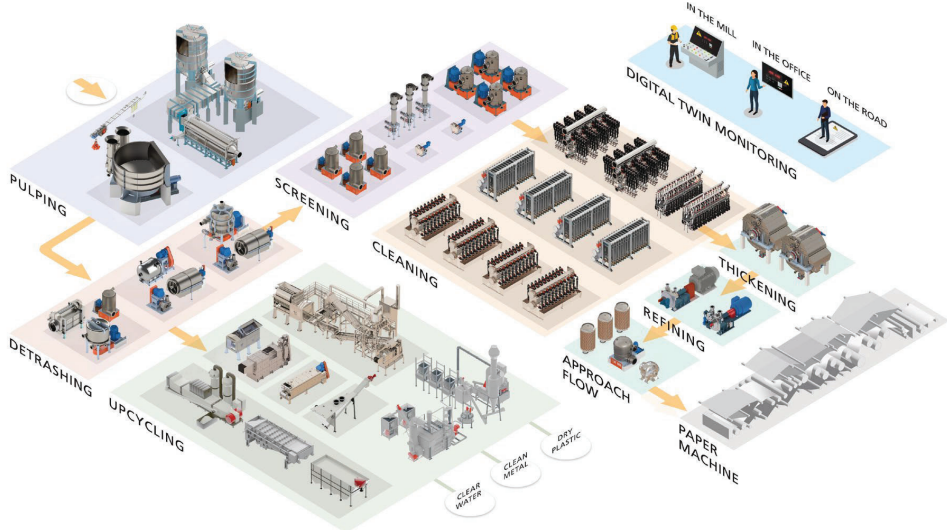

Industrial Processing

KEY ATTRIBUTES



Critical material breakdown equipment
Has the biggest impact on fiber recovery and system profitability



Replace-and-run wear parts
Strong aftermarket and service revenue stream



Large installed base
Dominant and established global market share



Strong growth and demand
Fiber is a regenerative, renewable, and sustainable resource

Industrial Processing

MARKET TRENDS

Favorable market trends driving demand growth and multiple value creation levers provide a compelling story for Kadant.

GLOBAL WOOD, PULP, & PAPER MARKET

(USD in billions)

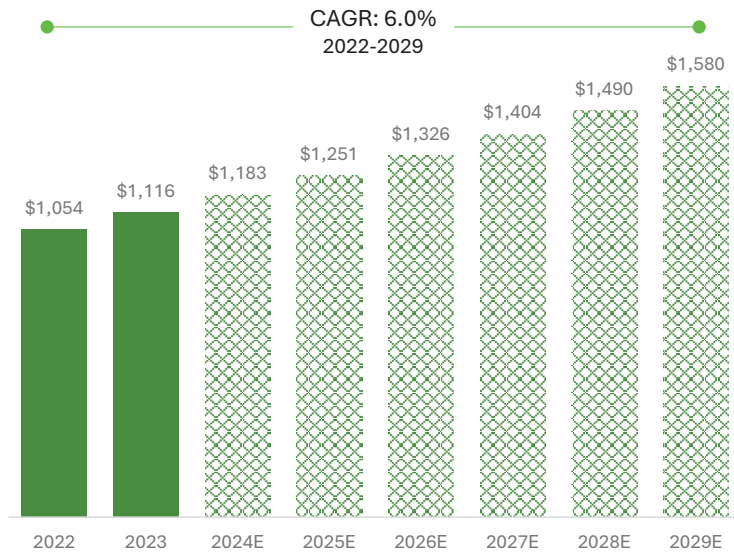

Source: The Business Research Directory, Precedence Research, Kadant analysis.



Decarbonization and electrification leading to increased demand for energy-optimized systems and new technologies utilizing green energy.



Disruptive technologies enabling new applications by increasing adoption of automation, advanced robotics, artificial intelligence, and rapidly expanding connectivity within process industries.



Population growth and demographic shifts create new opportunities compounded by labor shortages, aging workforce, and skills gaps.



Urbanization and aging infrastructure stimulating demand for convenience goods and services; recycling and waste management; and investments in infrastructure.



Sustainability and environmental responsibility fueling demand for increased use of recyclable (cellulose) materials to preserve and secure Earth's natural resources.

Industrial Processing

MARKET TRENDS

Key Drivers: U.S. Housing Starts

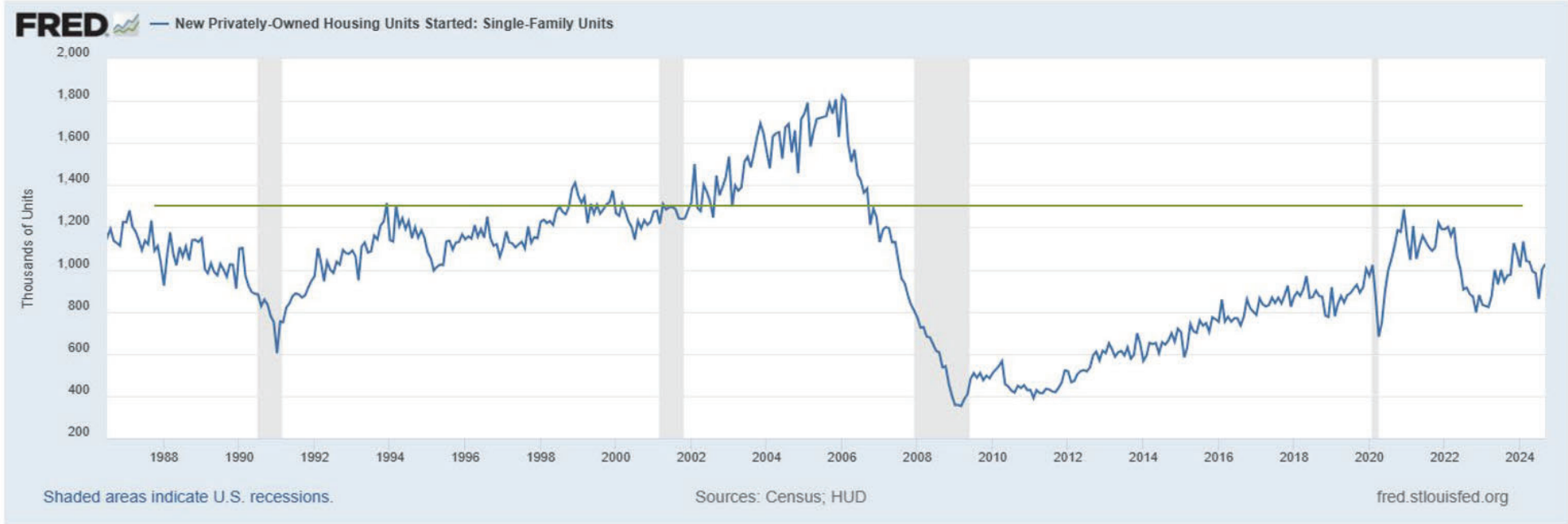

Source: St. Louis Fed data, Nov 2024 and Kadant analysis

Industrial Processing

MARKET TRENDS

Favorable market trends driving demand growth and multiple value creation levers provide a compelling story for Kadant.

GLOBAL WOOD, PULP, & PAPER MARKET

(USD in billions)

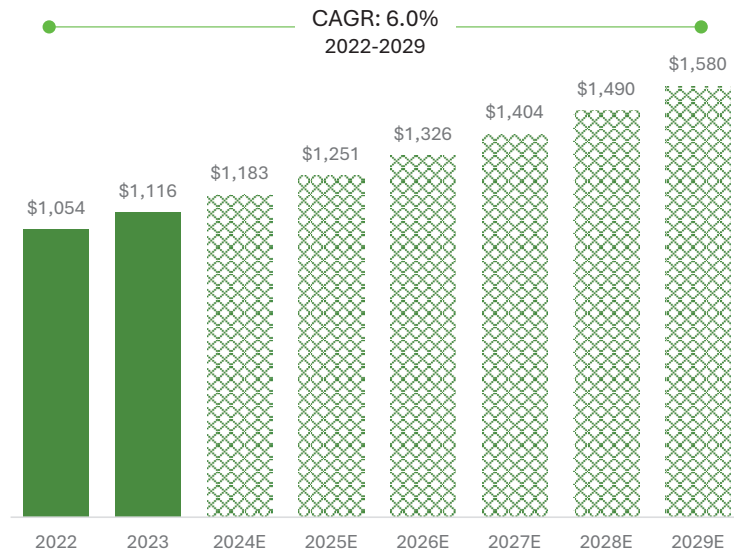

Source: The Business Research Directory, Precedence Research, Kadant analysis.



Decarbonization and electrification leading to increased demand for energy-optimized systems and new technologies utilizing green energy.



Disruptive technologies enabling new applications by increasing adoption of automation, advanced robotics, artificial intelligence, and rapidly expanding connectivity within process industries.



Population growth and demographic shifts create new opportunities compounded by labor shortages, aging workforce, and skills gaps.



Urbanization and aging infrastructure stimulating demand for convenience goods and services; recycling and waste management; and investments in infrastructure.



Sustainability and environmental responsibility fueling demand for increased use of recyclable (cellulose) materials to preserve and secure Earth's natural resources.

Wood Processing Product Line

INDUSTRIAL PROCESSING



MICHAEL COLWELL

Senior Vice President, Industrial Processing



Key Inputs

INDUSTRIAL PROCESSING • WOOD

Can you imagine a machine that:

- is 100% solar powered;
- removes carbon from the air;
- converts it to a strong, beautiful, sustainable building product; and,
- releases pure oxygen in the process?



Primary Product Offerings

INDUSTRIAL PROCESSING • WOOD

Number one in global market share for debarkers and stranders.³

DEBARKERS

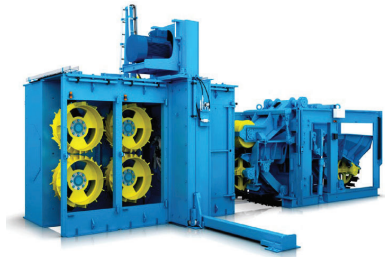

STRANDERS

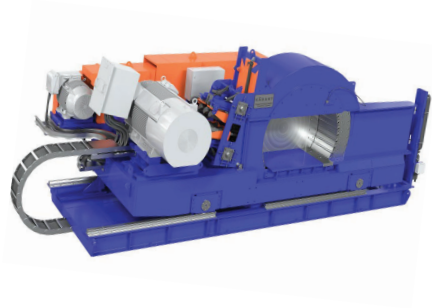

CHIPPERS



KNIFE SYSTEMS

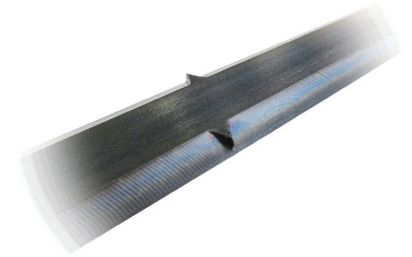

Primary Product Offerings

INDUSTRIAL PROCESSING • WOOD

Number one in global market share for debarkers and stranders.³

DEBARKERS

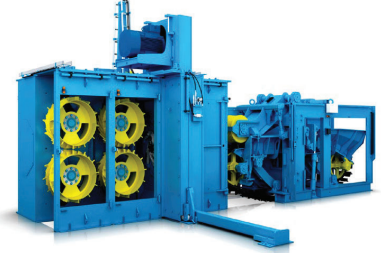

STRANDERS

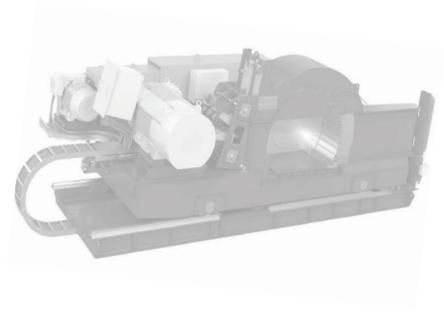

CHIPPERS



KNIFE SYSTEMS

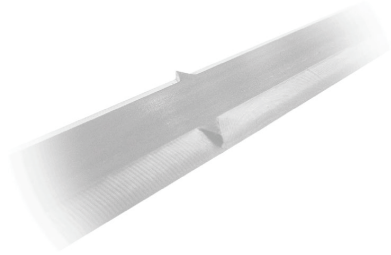

Primary Product Offerings

INDUSTRIAL PROCESSING • WOOD

Number one in global market share for debarkers and stranders.³

DEBARKERS

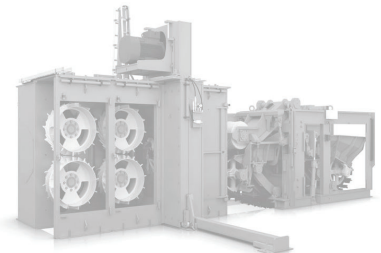

STRANDERS

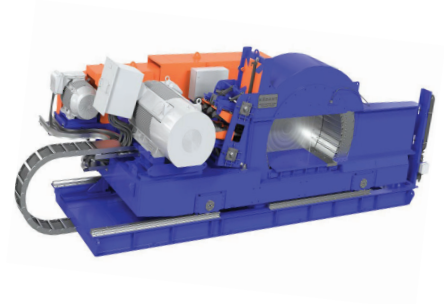

CHIPPERS



KNIFE SYSTEMS

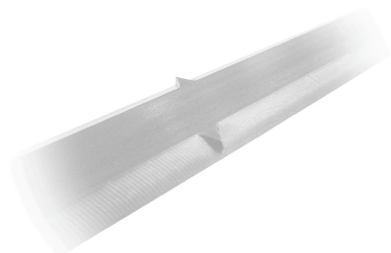

Primary Product Offerings

INDUSTRIAL PROCESSING • WOOD

Number one in global market share for debarkers and stranders.³

DEBARKERS

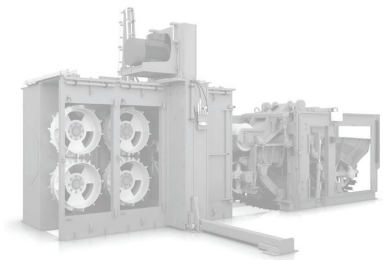

STRANDERS

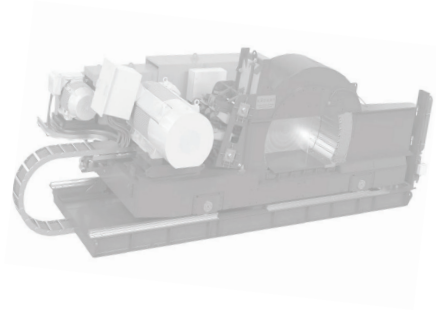

CHIPPERS



KNIFE SYSTEMS

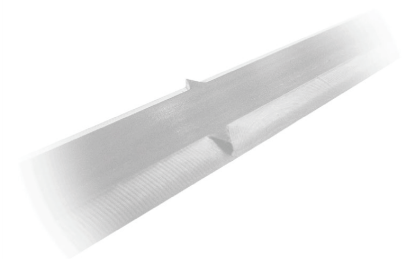

Primary Product Offerings

INDUSTRIAL PROCESSING • WOOD

Number one in global market share for debarkers and stranders.³

DEBARKERS

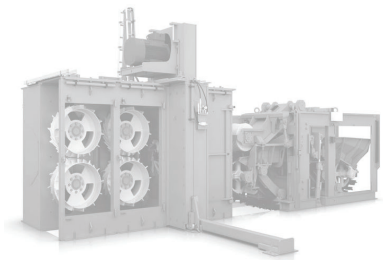

STRANDERS

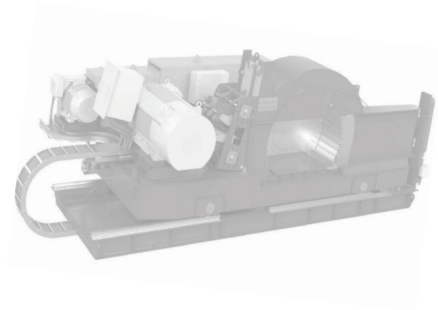

CHIPPERS

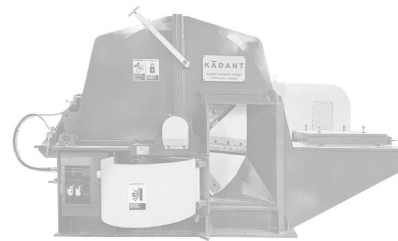

KNIFE SYSTEMS

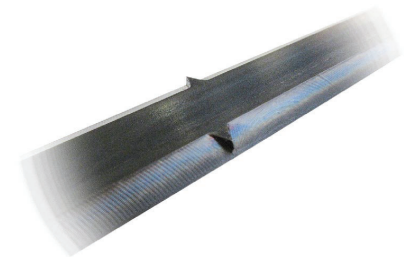

Value Proposition

INDUSTRIAL PROCESSING • WOOD

Nicholson



End Markets

INDUSTRIAL PROCESSING • WOOD

Our mill customers produce wood products for end markets with dynamic growth.

ORIENTED STRAND BOARD (OSB)



PLYWOOD



MEDIUM-DENSITY BOARD (MDF)



PARTICLE BOARD



BARK MULCH



WOOD CHIPS



DIMENSIONAL LUMBER



MASS TIMBER



End Markets

INDUSTRIAL PROCESSING • WOOD



Source: West Fraser Investor Presentation, October 2024

Innovation

INDUSTRIAL PROCESSING • WOOD

- Variable Flare Reducer

Innovation

INDUSTRIAL PROCESSING • WOOD

- Variable Flare Reducer
- Disposable Knife Systems

Innovation

INDUSTRIAL PROCESSING • WOOD

- Variable Flare Reducer
- Disposable Knife Systems
- Argus real-time Vision Systems featuring illumin.X technology

Value Proposition

INDUSTRIAL PROCESSING • WOOD



Fiber Processing Product Line

INDUSTRIAL PROCESSING



CHRIS DEMLER
President, Kadant Black Clawson

KĀDANT



Whole-System Offerings

INDUSTRIAL PROCESSING • FIBER

We engineer solutions and manufacture equipment for entire fiber processing systems.

PAPER RECYCLING SYSTEMS



REJECT HANDLING / UPCYCLING



VIRGIN FIBER SYSTEMS



End Markets

INDUSTRIAL PROCESSING • FIBER

Our customers produce products for end markets with stable demand.

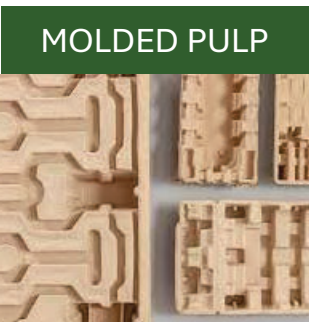
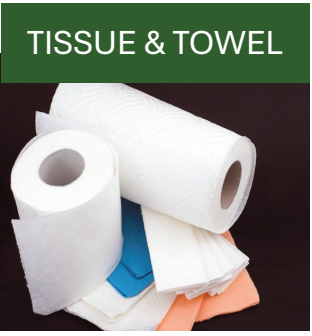
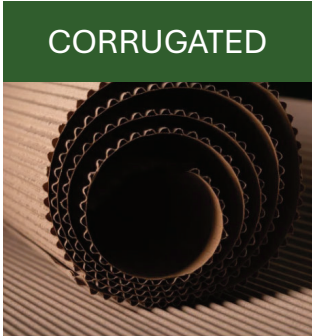

Paper Recycling Systems Encompass Multiple Systems

INDUSTRIAL PROCESSING • FIBER

PAPER RECYCLING SYSTEMS

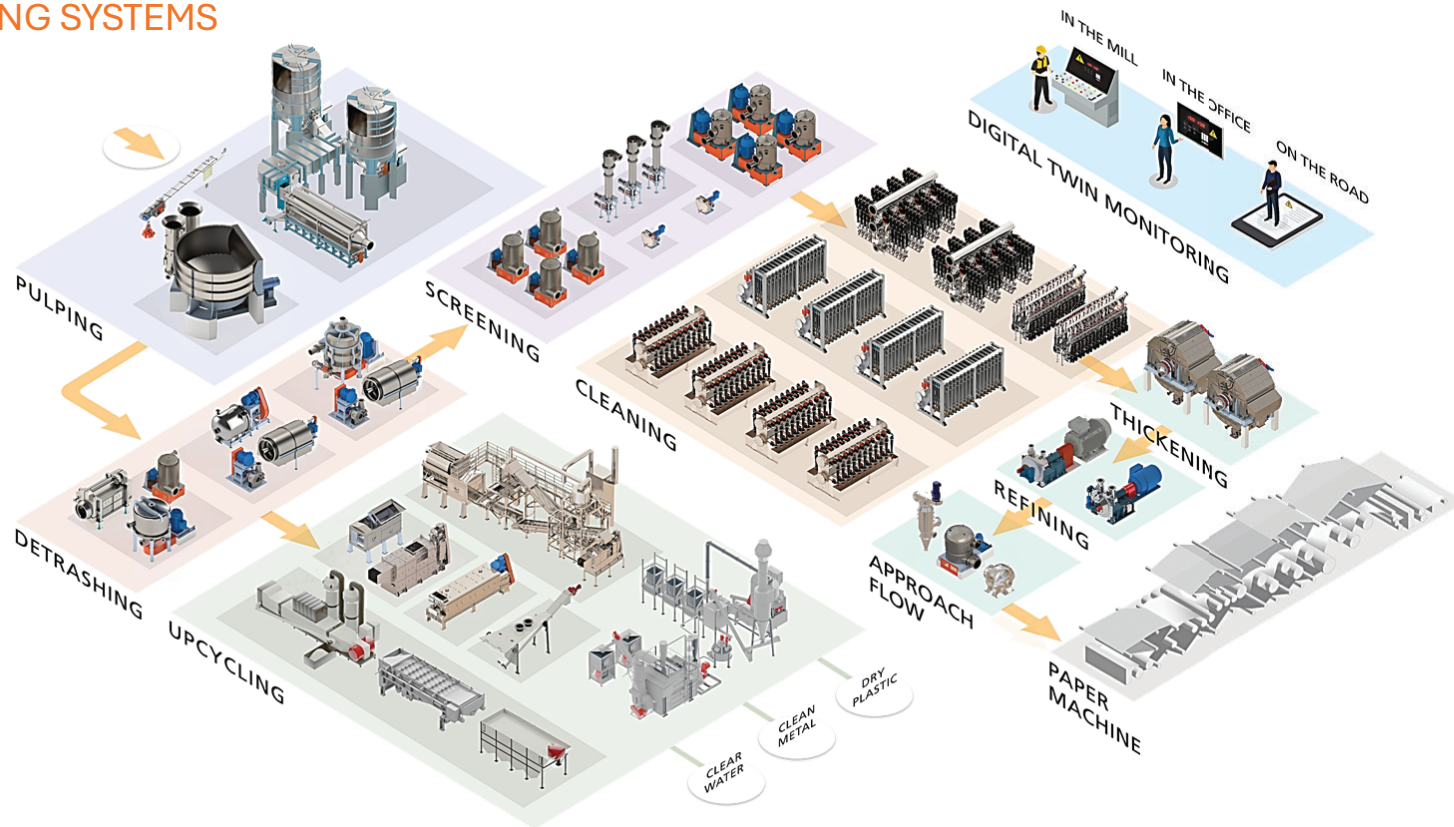

Paper Recycling System Case Study

INDUSTRIAL PROCESSING • FIBER

PAPER RECYCLING SYSTEMS

CASE STUDY

- A brownfield opportunity to revitalize a small town/facility
- Creative layout to utilize available equipment and adapt to the existing building space
- Worldclass system design to provide one-of-a-kind product quality



Reject Handling and Upcycling Systems

INDUSTRIAL PROCESSING • FIBER

REJECT HANDLING / UPCYCLING

CASE STUDY

- The client was paying €5 million per year to landfill 100 tons per day of plastic rejects and desired to reduce operating expense
- Our enhanced dewatering technology improved dryness by 50% and reduced water consumption and landfill expenses
- The client reported €1.5 million per year in disposal costs savings with a simple payback of about 6 months
- This success led to other projects including helping the client with mixed metal and plastic optimization

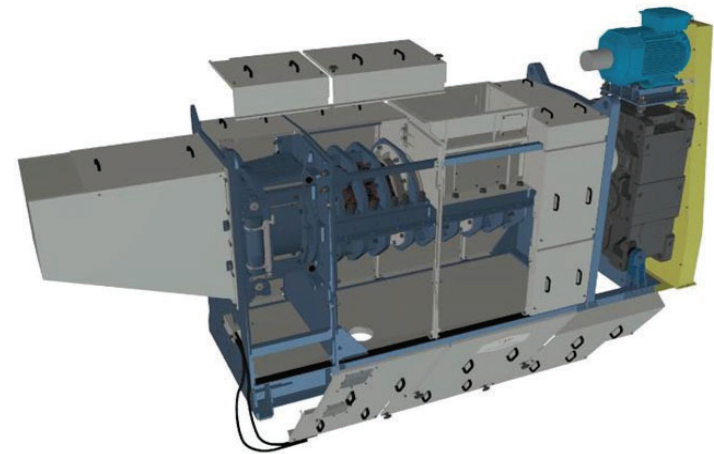

Virgin Fiber Systems Comprise Multiple Systems

INDUSTRIAL PROCESSING • FIBER

VIRGIN FIBER SYSTEMS



RECAUTISIZING



FIBERLINE & WASHING



HEAT TRANSFER
EVAPORATION



Virgin Fiber Systems Case Study

INDUSTRIAL PROCESSING • FIBER

VIRGIN FIBER SYSTEMS

CASE STUDY

- Paper producer had an emergency failure of a critical clarifier costing 300 tons per day and \$75,000 per day in lost production and increased costs
- They recognized Kadant had premium product and responsive support
- We provided system design, critical components, detail engineering, and balance of plant purchasing
- A new 70-ft diameter clarifier was up and running in just 28 weeks
- We saved them over \$5 million based on typical 12-month project schedule



UP & RUNNING

Innovation Process

INDUSTRIAL PROCESSING • FIBER

Systematic Inventive Thinking (SIT)

- A reproducible process using cross-functional teams to develop innovative and elegant solutions
- In use for over a decade to drive new product development

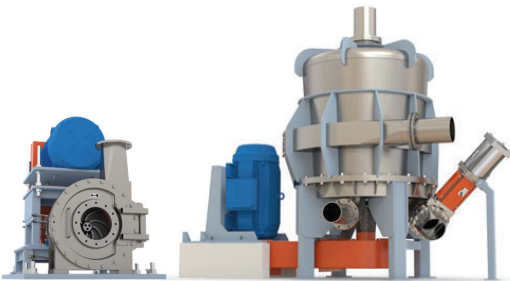
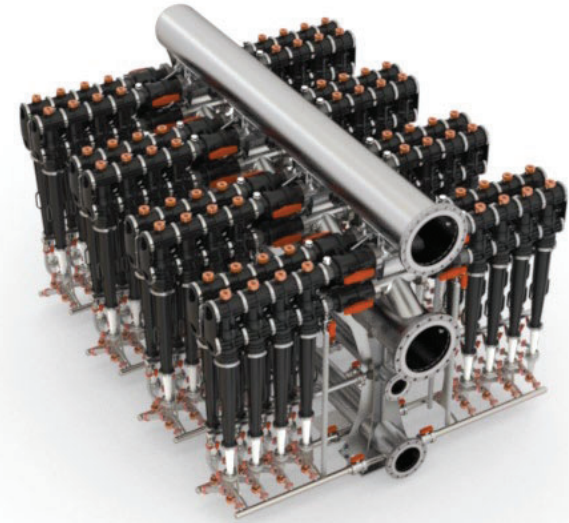

The first continuous detrashing system

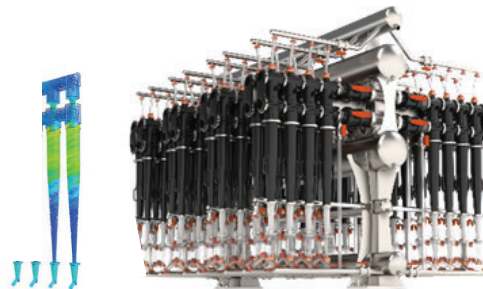

Patented; most efficient cleaner in market



Patented; market-leading clarifier system

Market Trends – Key Stats

INDUSTRIAL PROCESSING • FIBER

Paper and board is the most recycled packaging in Europe

Source: EUROSTAT, 2020 Packaging Recycling Rates

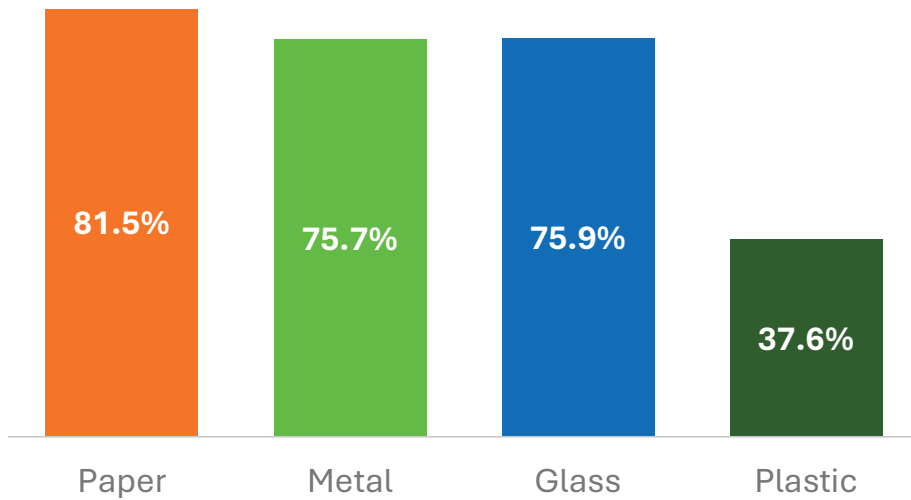

| PROGRAM TYPE | POPULATION WITH ACCESS | | COMMUNITIES WITH ACCESS | |
|--------------|------------------------|--------------------------|-------------------------|-----------------------|
| | Population (Millions) | Perception of U.S. Total | Number of comms. | Percent of U.S. Total |
| Curbside | 197 | 79% | 24,236 | 61% |
| Drop-off | 138 | 55% | 21,165 | 53% |
| Total | 235 | 94% | 33,360 | 84% |

94%

Market Trends – Key Stats

INDUSTRIAL PROCESSING • FIBER

Containerboard has been consolidating and is rebounding.

- Kadant has performed well providing aftermarket parts and expanded services and is positioned for growth

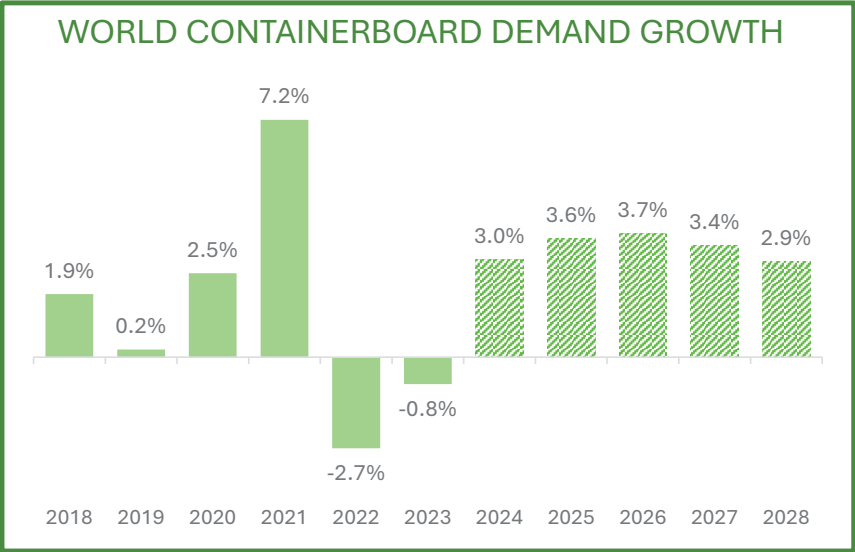

Source: RISI Fastmarkets, July 2024

Market Trends – Key Stats

INDUSTRIAL PROCESSING • FIBER

Containerboard has been consolidating and is rebounding.

- Kadant has performed well providing aftermarket parts and expanded services and is positioned for growth

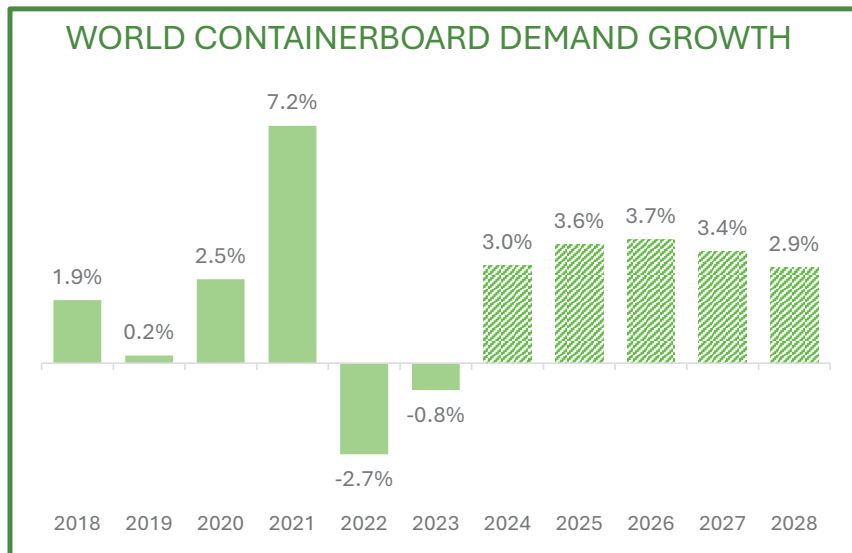

Source: RISI Fastmarkets, July 2024

Demand for molded fiber packaging is forecast to rise 7.8% annually.

- Recyclable, compostable, biodegradable, and increasingly made from agricultural waste
- Coatings and additives, like Kadant BioFiber®, will increase molded fiber applications
- New products such as molded fiber beverage bottles

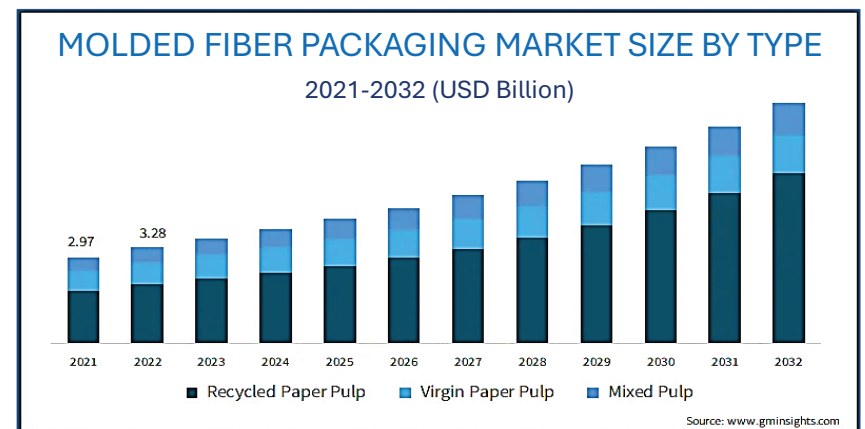

<https://www.freedoniagroup.com/industry-study/us-molded-fiber-packaging>

Market Trends – Key Stats

INDUSTRIAL PROCESSING • FIBER

- **35%** of microplastics in oceans come from clothing
- **92 million** tons per year of textile becomes waste
- **Only 1%** of clothing is recycled into new garments



Source: TheRoundup.org

Expanding Our Growth Prospects

INDUSTRIAL PROCESSING • FIBER



- Offer digital twin process modeling and training
- Provide machine health sensor packages and monitoring services
- Develop AI process health analytics and optimization tools / services



- People-first service bundles: engineers, process, and digital support products
- Provide EPC plant design and installation services that mill teams are no longer able to do



- Advance upcycling products and integrate with recycling system solutions
- Utilize our fiber processing expertise to lead the emerging textile recycling business

Industrial Processing

KEY ATTRIBUTES



Critical material breakdown equipment
Has the biggest impact on fiber recovery and system profitability



Replace-and-run wear parts
Strong aftermarket and service revenue stream



Large installed base
Dominant and established global market share



Strong growth and demand
Fiber is a regenerative, renewable, and sustainable resource

10 Minute Break

KĀDANT



Acquisition Strategy and 80/20



DARA MITCHELL

Senior Vice President, Corporate Development



Proven Track Record of Successful M&A



Types of Acquisitions and Where They Come From

TUCK-INS

Driven by Kadant's divisions to ramp their strategic initiatives

STRATEGIC STAND-ALONES

Over 500 identified targets with the goal to avoid a process or at least be the "favorite"

NEW PLATFORMS

Relationships with 150+ bankers who show us new platform ideas

Identifying and Acquiring the Best Businesses

TYPICAL YEAR

120+ Actionable Opportunities



15+ Indications of Interest



~3 Acquisitions

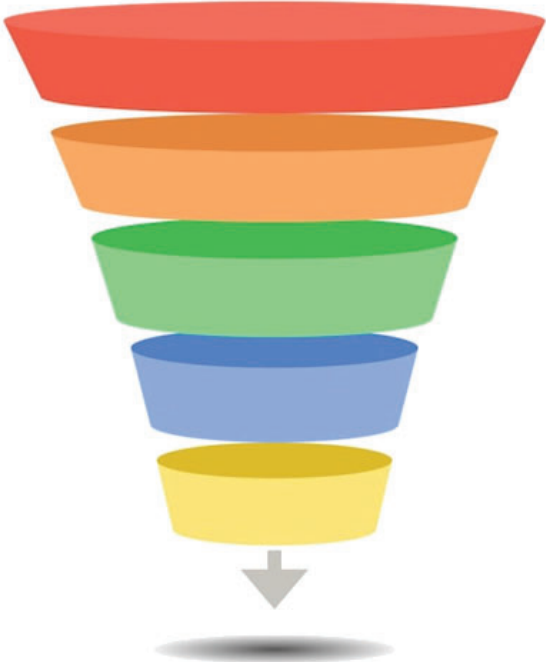

Predominantly Proprietary Acquisitions Since 2019

TUCK-INS

Flow Control

- Solcera

Industrial Processing

- Celtec
- Frontway
- Tornado Pulper
- Lindsay

Material Handling

- Conveyors Plus
- MacService

STRATEGIC STAND-ALONES

Flow Control

- Clouth
- DSTI

Industrial Processing

- Kadant India
- Cogent
- Key Knife

Material Handling

- Balemaster
- KWS

NEW PLATFORMS

Material Handling

- Syntron

14/16

acquisitions sourced
via existing relationships

Our Approach to Making Acquisitions Successful

- Acquisition Criteria
- Acquisition Price Paid
- Unlocking Value



Key Knife: Acquired in 2024

Strong Business

- **Mission Critical:** Significant impact on wood fiber optimization
- **Attractive Market:** Key market for Kadant
- **Market Position:** Market leader in disposable knife systems
- **Robust Financials:** 100% aftermarket parts with excellent margins
- **Customer Retention:** Large worldwide installed customer base

Reasonable Prices

- Leveraged relationships to position Kadant as the best “home” for a unique ESOP business and avoid a process.

Preserve and Enhance Value

- Decentralized model ideal platform for ESOP
- Key Knife working with other wood processing businesses to leverage growth synergies

Creating Value: Best of Both Worlds

INDEPENDENCE THROUGH DECENTRALIZATION WITH ACCESS TO KADANT VALUE ENHANCERS

- 80/20 program
- Pricing engine
- LEAN manufacturing
- Focus on driving aftermarket parts
- Leveraging illumina.X digital platform
- Geographic footprint and internal networking
- Support for acquisitions
- Being part of a public company

Financial Impact of Acquisitions

Since 2013:

- Completed 24 acquisitions
- Average deal multiple 8.8x through the period
- Represent 56% of forecasted 2024 revenue
- Represent 64% of forecasted 2024 adjusted EBITDA

Acquisition Performance

Average adjusted ROIC⁶ for 2023: 15%



The Next 5 Years: Acquisition Strategy

- Continue to add strategic stand-alones and tuck-ins to leverage core markets
- Selectively acquire new platforms in ancillary markets that strengthen the depth and breadth of Kadant
- Maintain decentralized operating model
- Maintain discipline in acquisition criteria



80/20

Serving our best customers even better.

KĀDANT



80/20 Explained

20% of efforts lead to 80% of results

- Products
- Customers

The Pareto Principle

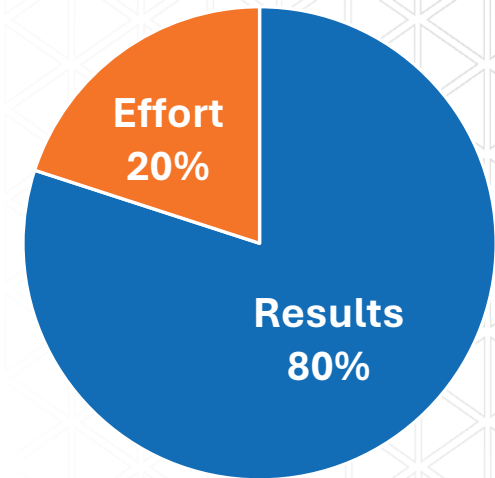

FOCUS ON TREATING YOUR BEST CUSTOMERS EVEN BETTER

80/20 Benefits

- Reduces complexity
- Deepens key customer relationships
- Drives profitable revenue growth
- Provides focus
- Frees up time
- Empowers employees
- Improves profit
- Decreases invested capital



Our 80/20 Process

- Heavily data-driven
- Cross-functional teams focused on simplifying the business and expanding growth
- Large numbers of people within the business working on teams
- Recommendations are bottom-up not top-down
- Not a “project” but a way of running the business
- Typically takes 18-24 months to see meaningful results



Product Simplification Team

NORTH AMERICAN DOCTOR BLADE BUSINESS

- Team objective was to reduce number of materials and configurations offered, removing complexity
- Multi-function team: Applications, R&D, Engineering, Manufacturing, Sales, Stock Room
- Systematically analyzed data from both product and customer perspective
- Then able to apply the process to European blades business reducing ceramic and composite blade materials

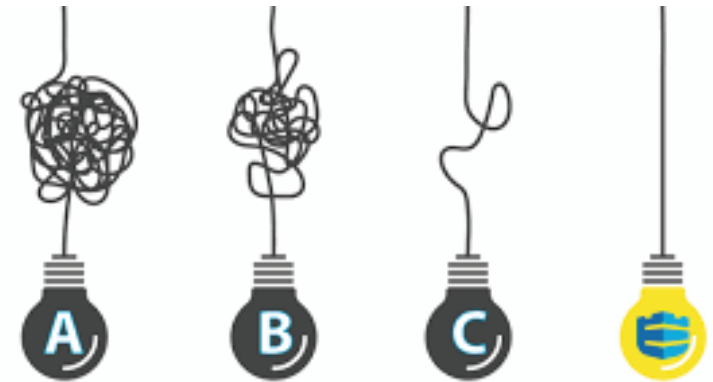

Product Simplification: Doctor Blades

REDUCTIONS

North America

37% Materials

50% Configurations



Europe

74% Materials

85% Configurations



RESULTS

- Simplified manufacturing process
- Easier sales process
- Streamlined supply chain
- Reduced inventory

“Keeping inventory is much easier. We are now standardizing which saves production time by allowing us to make more standard products.”

- Tommy B., metal line lead and assistant supervisor

Transformative Qualitative Benefits

- Identifying top talent
- Employee engagement through meaningful work, and empowerment through impacting change
- Increased communication across business functions
- Focused new product development
- Targeted market expansion
- Efficiency mindset applied to other processes

80/20 Revenue Distribution

2024F Revenue Under 80/20 Program

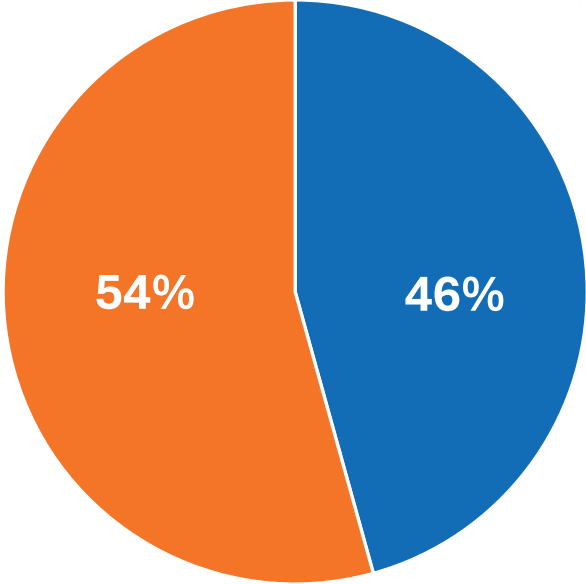

■ Subsidiaries Under 80/20 ■ Remaining Subsidiaries

80/20 and Acquisitions: The Fit

Challenge

Synergies are elusive and difficult to obtain making it challenging to achieve strong returns in a competitive deal market.

Value Enhancer

80/20 is highly effective, value enhancing and works especially well with a decentralized operating model.



Actual Results of 80/20 on Acquired Entity

ACQUISITION MADE IN 2019; STARTED 80/20 IN 2020

| (\$ millions) | 2023 | 2020 | CHANGE |
|--|---------|--------|---------|
| Revenue | \$112.6 | \$79.3 | 42.0% |
| Gross Margin | 35.2% | 30.7% | 450 bps |
| SG&A, excluding intangible amortization, as % of revenue | 10.8% | 13.4% | 260 bps |
| Adjusted EBITDA* | \$28.9 | \$15.2 | 90.1% |
| Adjusted EBITDA Margin* | 25.7% | 19.1% | 660 bps |
| Number of Parts | 11,319 | 13,763 | (17.8%) |

Delivering Sustainable Value

FINANCIAL REVIEW



MICHAEL J. MCKENNEY
Executive Vice President & CFO

KĀDANT

Value Creation for Kadant Shareholders

KEY FINANCIAL ATTRIBUTES

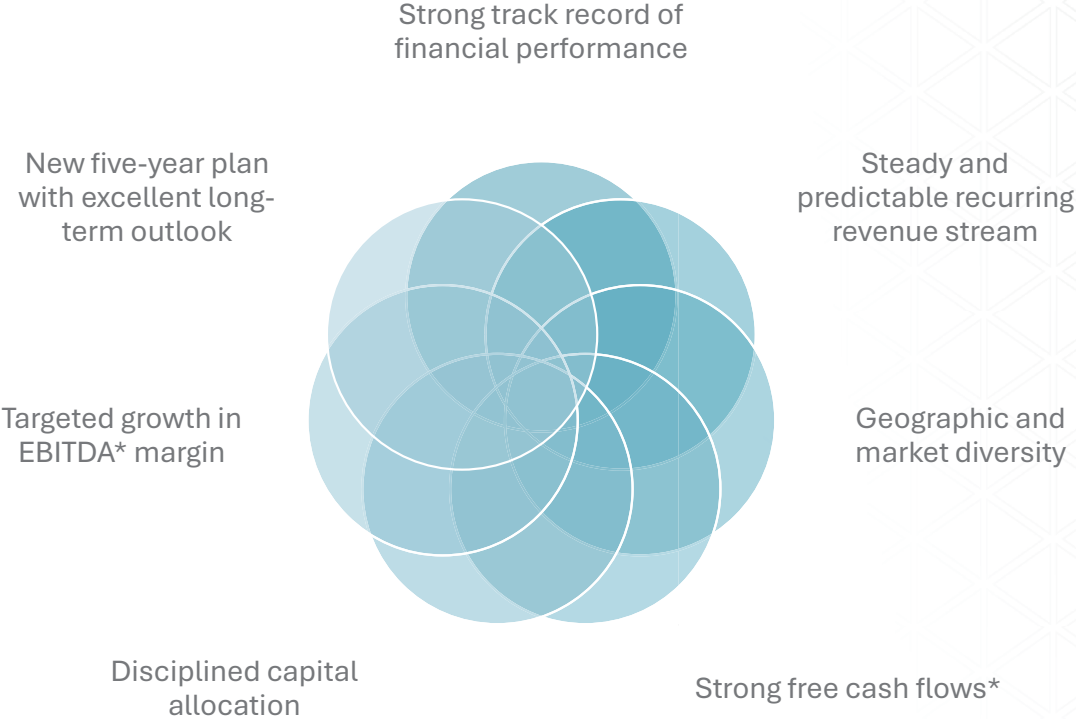

Driving Profitable Growth

KADANT 2018 v. 2023

(USD in millions, except per share amount)



**Kadant performance surpasses
most industrial companies.**



Baird Industrial Company Composite Benchmarking

KADANT PERFORMANCE COMPS



The Baird Industrial Company Composite represents **484 companies** which Baird views as indicative of the publicly traded industrial company universe.

Kadant Comparison to Other Industrials

BAIRD INDUSTRIAL COMPANY COMPOSITE (BICC)

2024F REVENUE GROWTH

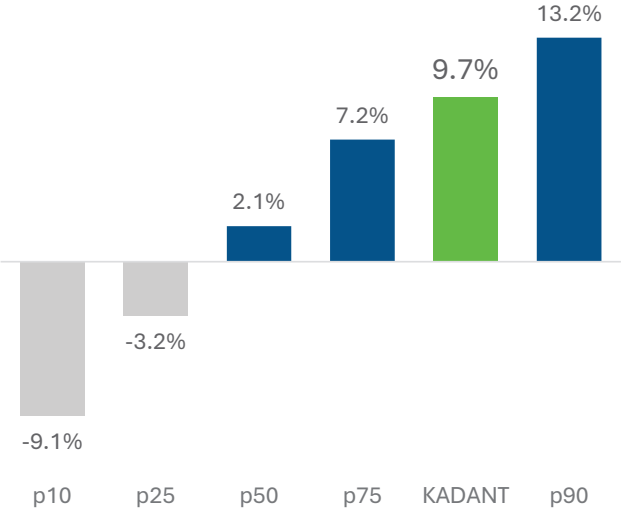

2023 GROSS MARGIN

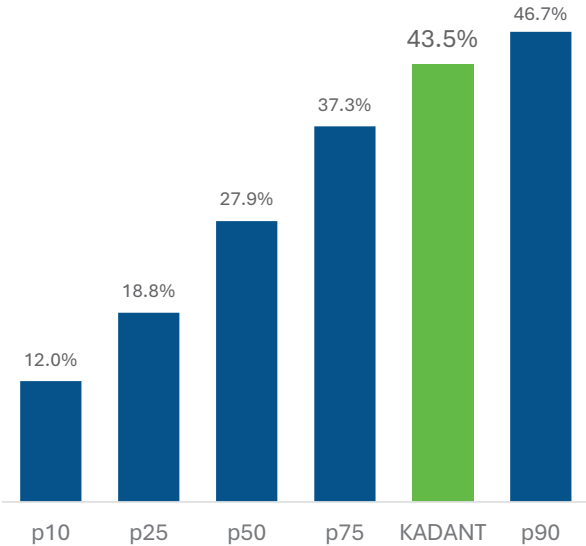

Kadant Comparison to Other Industrials

BAIRD INDUSTRIAL COMPANY COMPOSITE (BICC)

2023 ADJUSTED EBITDA MARGIN*

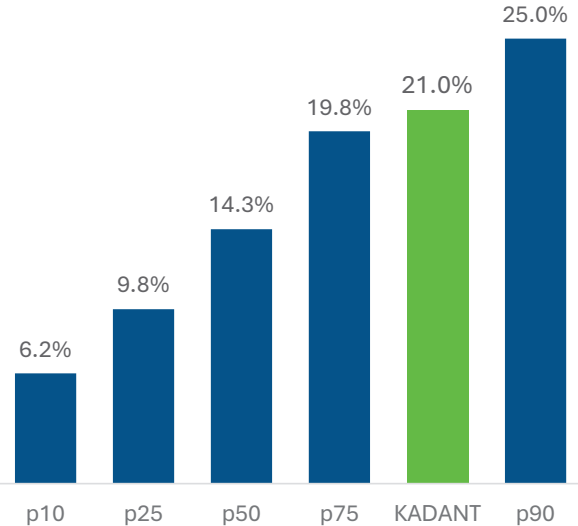

2023 ROIC⁵

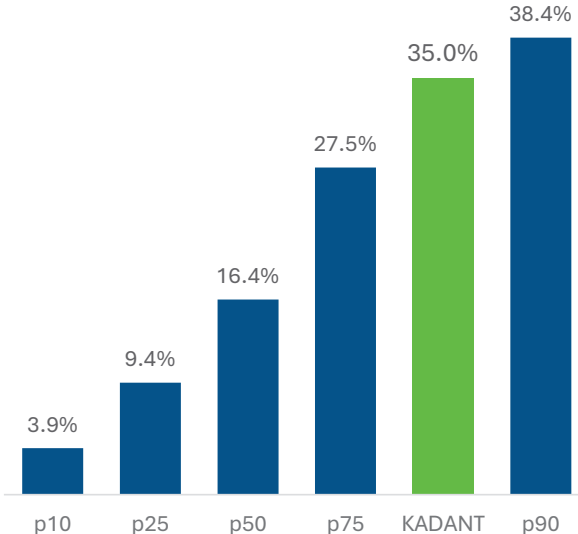

Strong Track Record of High Performance

TOTAL SHAREHOLDER RETURN (2023)

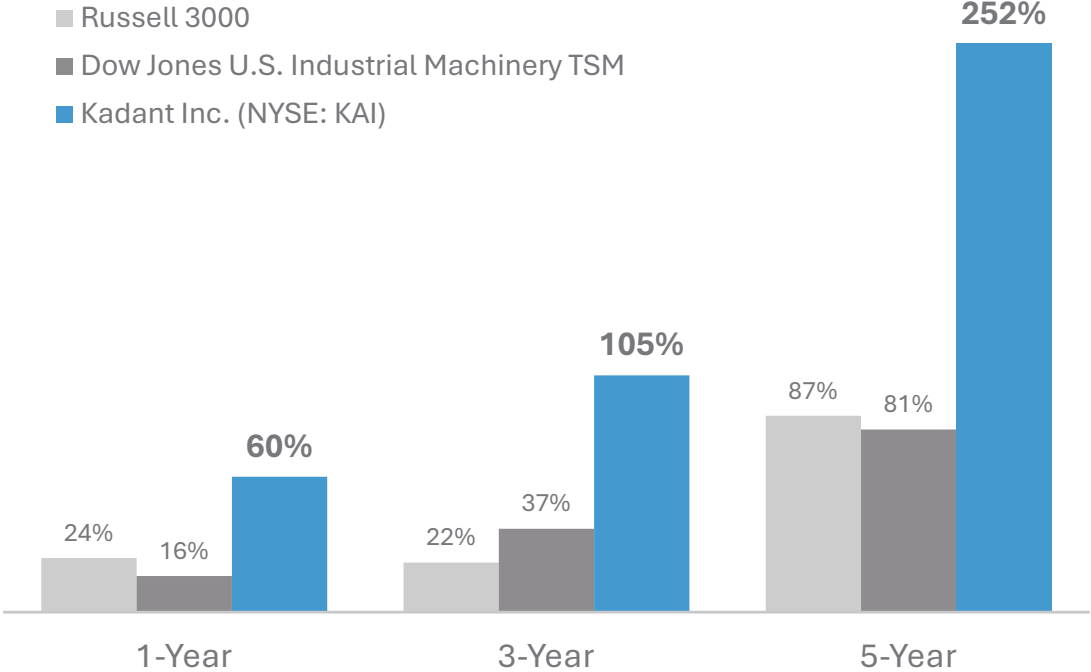

Steady and Predictable Recurring Revenue Stream

AFTERMARKET PARTS v. CAPITAL REVENUE

FY 2023

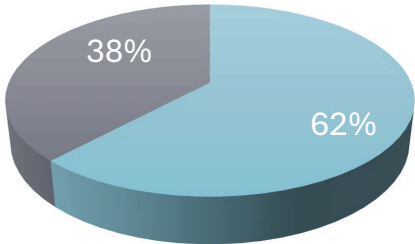

Q3 YTD 2024

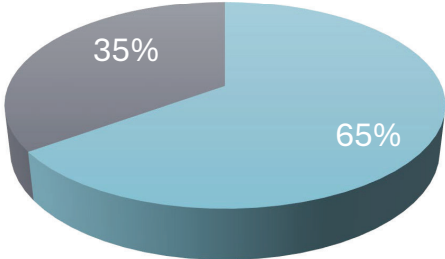

■ Aftermarket Parts ■ Capital

HIGHLIGHTS

- Large installed base and new capital orders drive recurring parts sales
- Razor / razor blade opportunities
- Higher gross margins
- Reduces revenue volatility
- Enhances customer relationship

Advantages of Geographic and Market Diversity

2023 REVENUE SOURCE

REVENUE BY CUSTOMER LOCATION

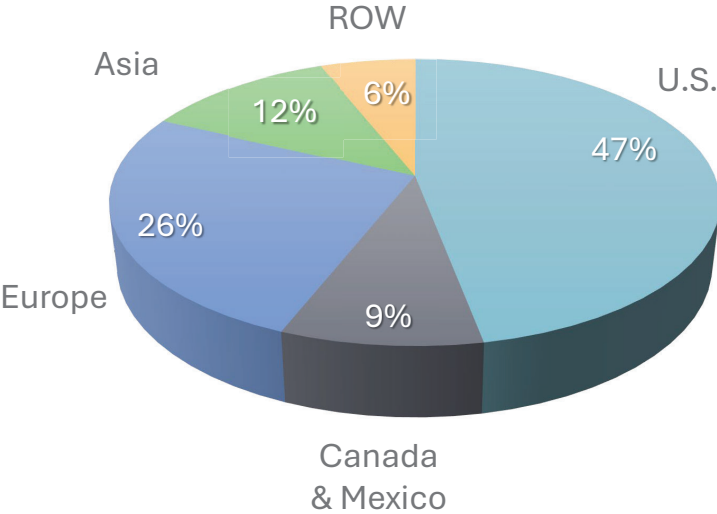

REVENUE BY END MARKET

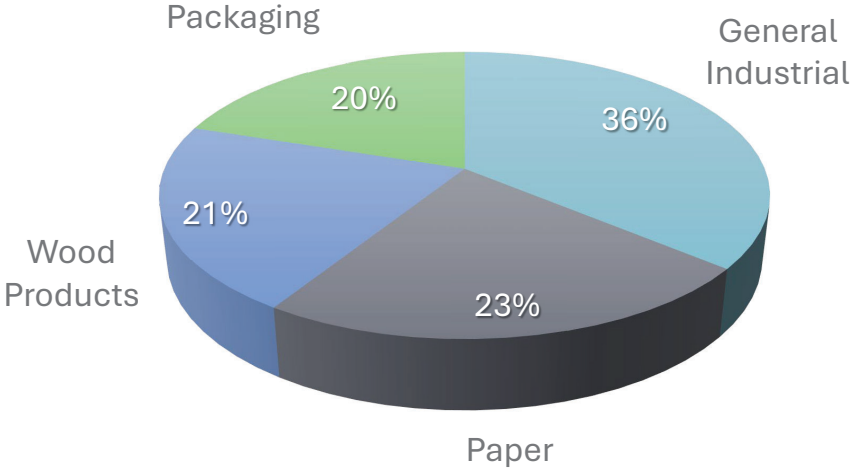

Strong Adjusted Free Cash Flow*

DRIVEN BY PREMIUM POSITIONING AND LARGE INSTALLED BASE

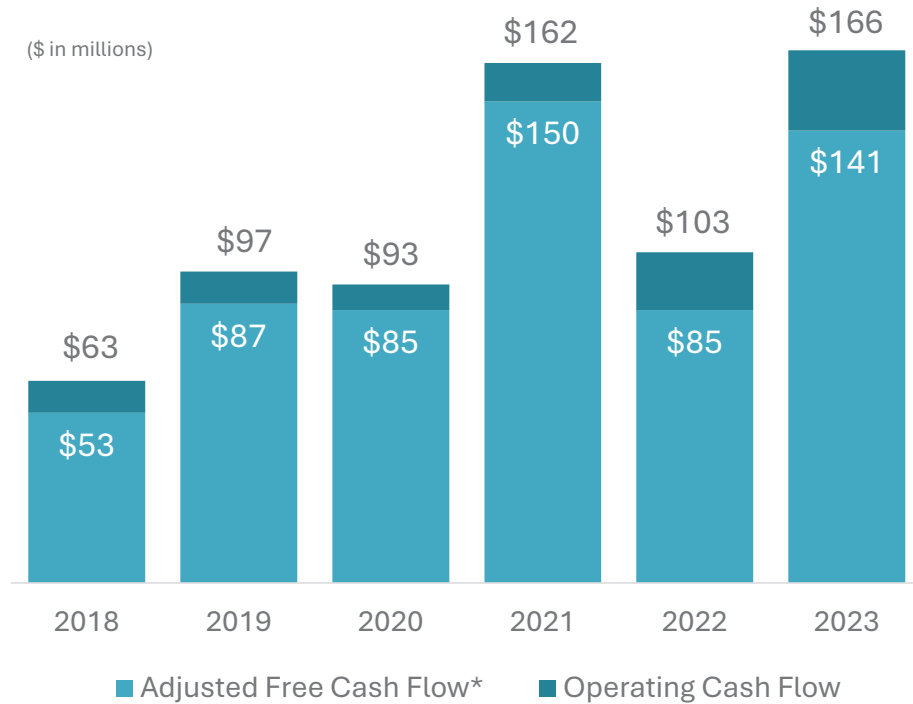

HIGHLIGHTS

- Solid track record of debt paydowns
- Leverage ratio⁷ target $\leq 2.5\%$, currently at 1.13
- Capex as % of revenue approximately 2% to 2.5%
- Working capital target 12% to 15% of revenue
- R&D approximately 1.5% of revenue

Disciplined Capital Deployment

CAPITAL ALLOCATION 2019-2023

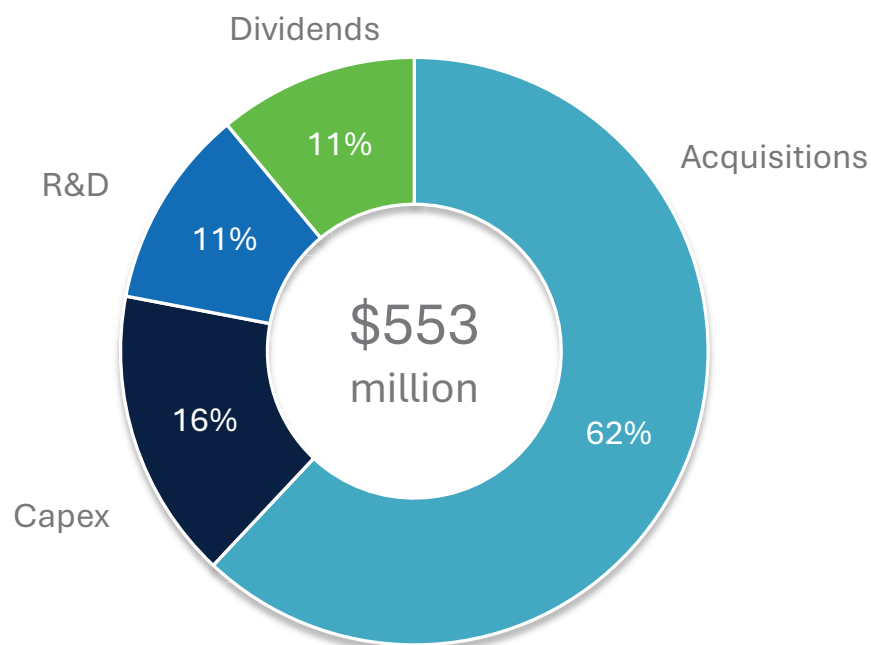

HIGHLIGHTS

- \$345 million invested in acquisitions
- Average acquisition multiple of 9.2x
- Average adjusted ROIC⁶ for significant acquisitions completed since 2013 is 15%
- Cash dividends have increased every year with 6.5% CAGR
- Adjusted free cash flow* as a % of adjusted net income* averaged 130%

FIVE-YEAR FINANCIAL TARGETS

HISTORICAL PERFORMANCE

KĀDANT

Five-Year Financial Targets for 2017

| | Base 2012 | Target for 2017 | Actual 2017 |
|------------------|----------------|-----------------------|---------------|
| Revenue | \$332 million | \$500 - \$550 million | \$515 million |
| Adjusted EBITDA* | \$45 million | \$60 - \$80 million | \$92 million |
| Adjusted EPS* | \$2.29 | \$4.00 - \$5.00 | \$4.49 |
| Free Cash Flow* | \$25 million | \$45 - \$60 million | \$48 million |
| Net (Cash) Debt | (\$48) million | \$45 million | \$165 million |

Five-Year Financial Targets for 2021

| | Base 2016 | Target for 2021 | Actual 2021 |
|------------------|---------------|-----------------------|---------------|
| Revenue | \$414 million | \$700 - \$800 million | \$787 million |
| Adjusted EBITDA* | \$62 million | \$100 - \$125 million | \$159 million |
| Adjusted EPS* | \$3.10 | \$5.00 - \$6.00 | \$7.83 |
| Free Cash Flow* | \$45 million | \$70 - \$80 million | \$150 million |
| Net (Cash) Debt | (\$7) million | \$60 - \$140 million | \$175 million |

Five-Year Financial Targets for 2023

| | Base 2018 | Target for 2023 | Actual 2023 |
|-----------------------------|---------------|-----------------------|---------------|
| Revenue | \$634 million | \$1 - \$1.2 billion | \$958 million |
| Adjusted EBITDA* | \$115 million | \$210 - \$230 million | \$201 million |
| Adjusted EBITDA Margin* | 18.2% | 20.0% | 21.0% |
| Adjusted EPS* | \$5.34 | \$8.00 - \$9.00 | \$10.04 |
| Adjusted Free Cash Flow* | \$53 million | \$140 - \$160 million | \$141 million |
| Net Debt | \$130 million | \$225 - \$245 million | \$4.4 million |
| Leverage Ratio ⁷ | 1.19x | 1.10 – 1.20x | 0.27x |

Revenue and Adjusted EPS* Performance

DELIVERING CONSISTENT LONG-TERM GROWTH

REVENUE

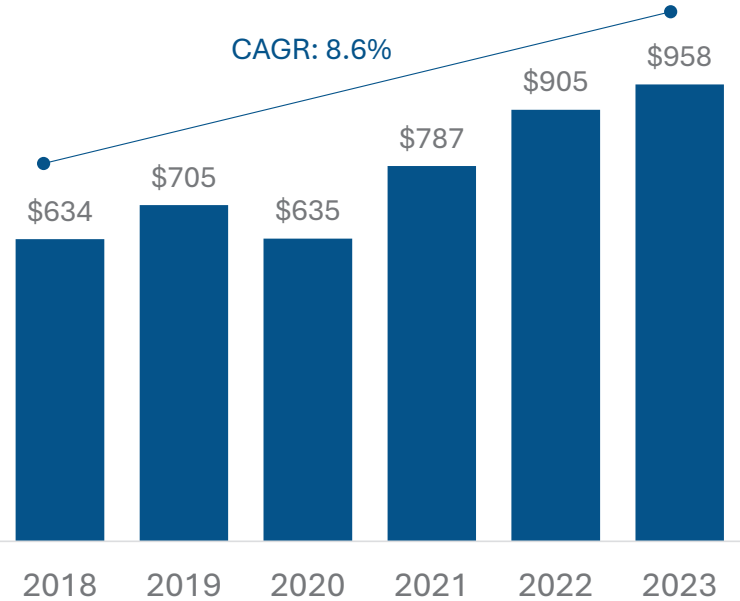

ADJUSTED EPS*

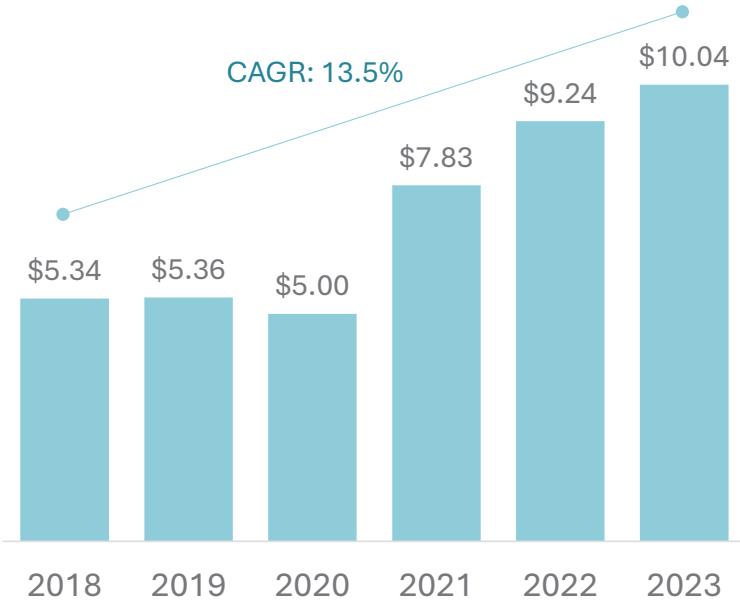

Targeted Growth in EBITDA Margin*

ENHANCING OUR MARGIN PROFILE

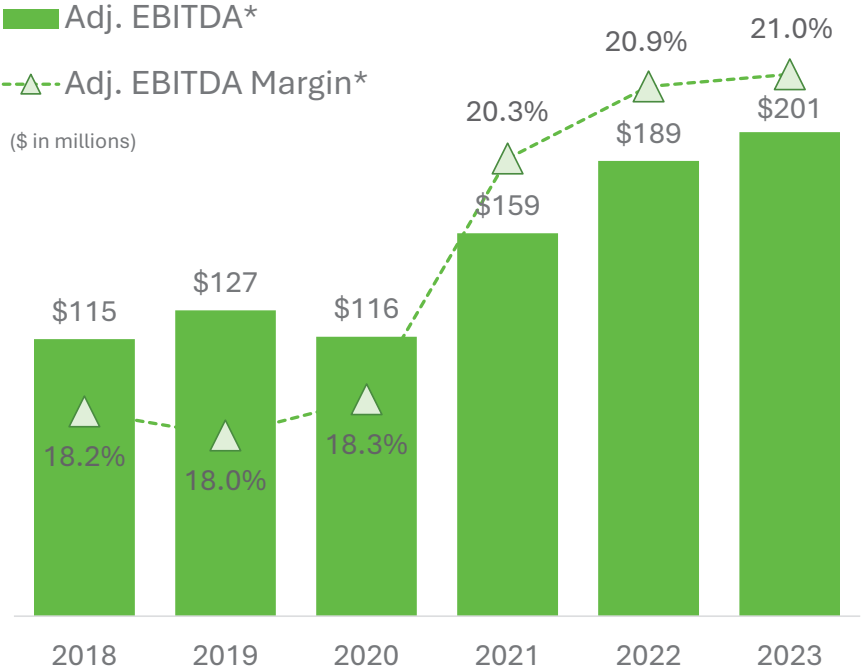

HIGHLIGHTS

- Key financial metric
- 280 bps improvement over 5 Years
- 800 bps improvement over 10 Years
- New adjusted EBITDA margin* target of 23%+

Improving Operating Leverage to Maximize Value

STRONG EXECUTION CAPABILITIES ENHANCE PROFITABLE GROWTH

Adjusted SG&A* as a % of Revenue

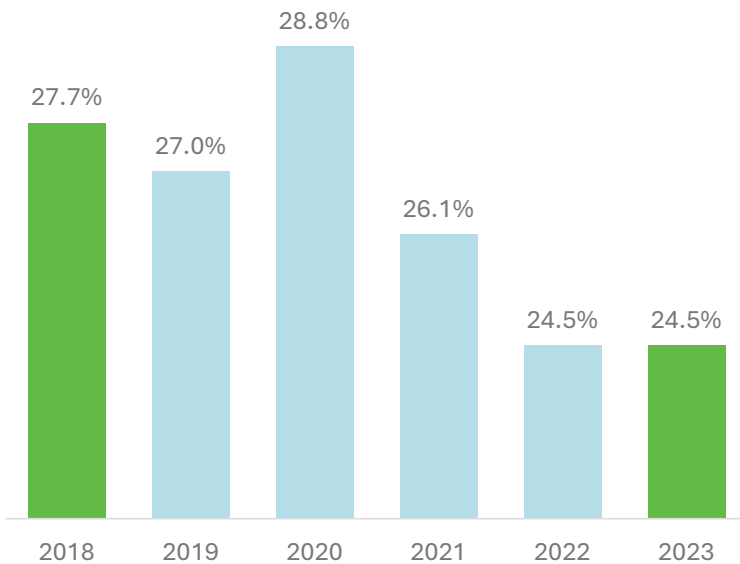

HIGHLIGHTS

- 320 bps improvement over 5 years
- 880 bps improvement over 10 years
- Contributions from 80/20 program
- Leverage automation and lean operating principles
- Continue to improve operating leverage

2024-2028 FIVE-YEAR PLAN

KĀDANT

2024-2028 Five Year Plan

FINANCIAL TARGETS & ASSUMPTIONS

| | 2023 | 2028 TARGET |
|--------------------------|---------|-------------------|
| Revenue | \$958 | \$1,500 - \$1,800 |
| Adjusted EBITDA* | \$201 | \$340 - \$405 |
| Adjusted EBITDA Margin* | 21.0% | 23.0% + |
| Adjusted EPS* | \$10.04 | \$15.00 - \$18.00 |
| Adjusted Free Cash Flow* | \$141 | \$240 - \$280 |

(\$ in millions except per share amount)

ASSUMPTIONS

- Economic growth will be moderate yet steady throughout the period
- Industrial demand will track closely to GDP growth
- Organic growth of 3% to 5% will benefit from numerous internal programs, including 80/20 and other initiatives
- Growth via acquisitions expected to be 6% to 8%

Excellent Long-Term Outlook

REVENUE AND ADJUSTED EBITDA* GROWTH

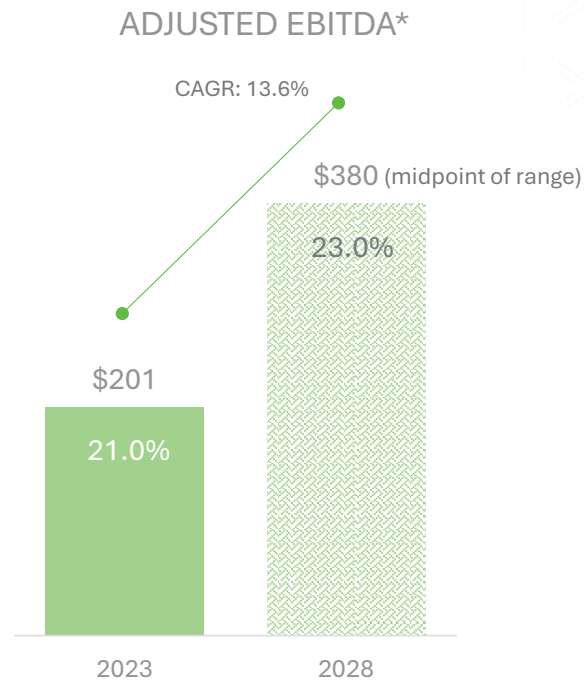
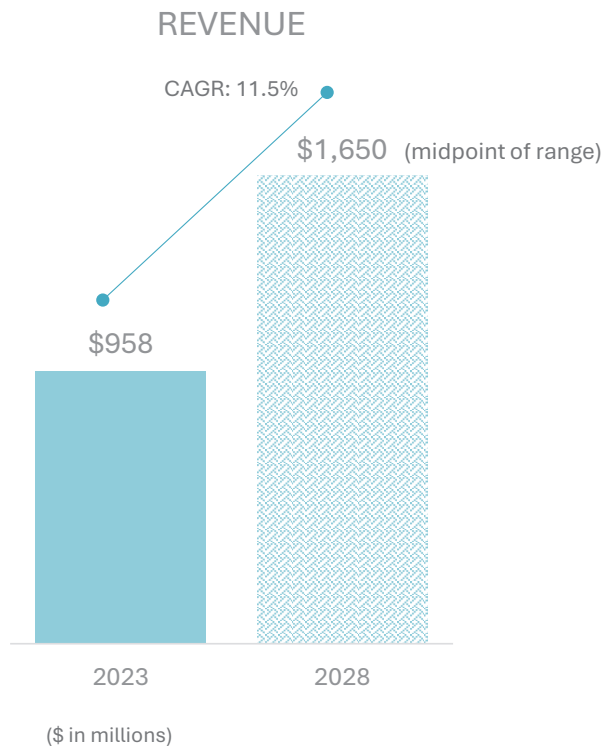



KĀDANT

Summary & Conclusion

JEFFREY L. POWELL
President & Chief Executive Officer

Value Creation for Kadant Shareholders

TECHNOLOGY THAT DRIVES SUSTAINABLE INDUSTRIAL PROCESSING®

- Growing end markets driven by global macro trends
- Decentralized structure, asset-light operating model
- Strong track record of financial performance
- Strong free cash flows*
- Disciplined capital allocation and proven record of value-creating acquisitions
- Experienced management team

Value Creation for Kadant Shareholders

CONSISTENTLY DELIVERING GROWTH FOR OUR SHAREHOLDERS

ADJUSTED EBITDA MARGIN*

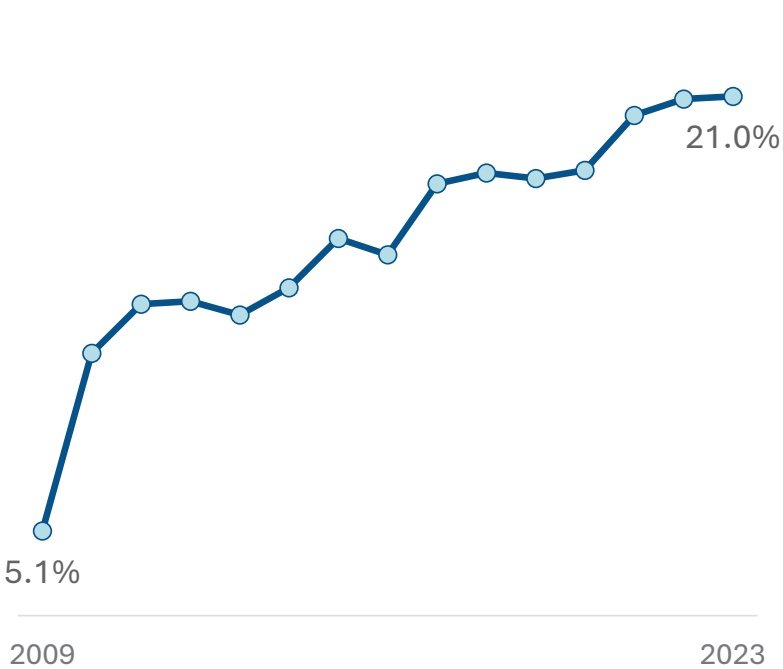

ADJUSTED SG&A*
(as a % of revenue)

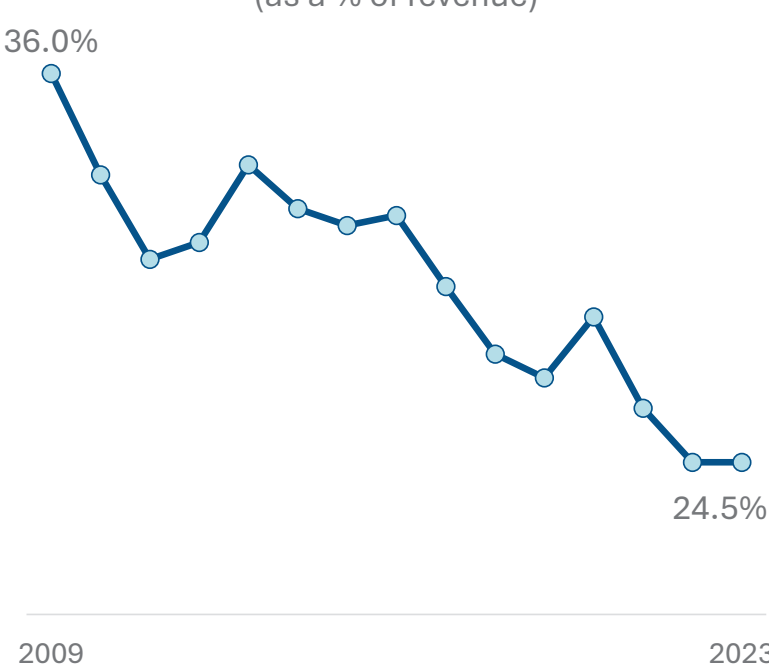

Value Creation for Kadant Shareholders

CONSISTENTLY DELIVERING GROWTH FOR OUR SHAREHOLDERS

(\$ in millions except per share amounts)

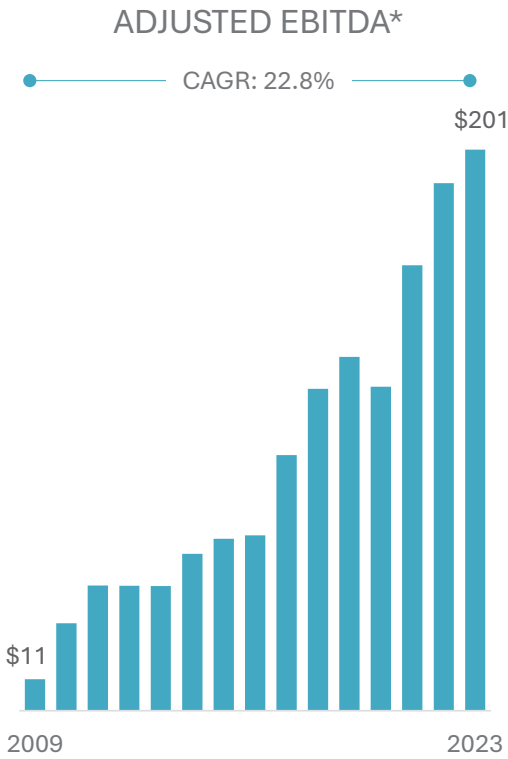
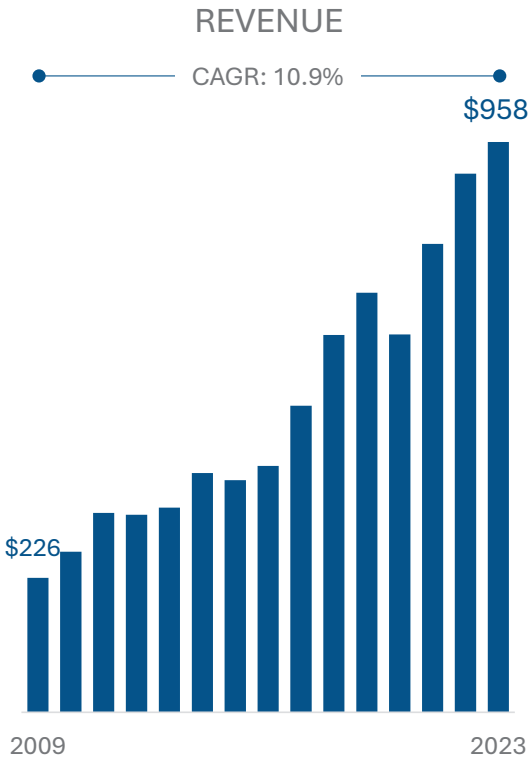



KĀDANT

Question & Answer

Appendix

KADANT 2024 INVESTOR DAY

KĀDANT

Adjusted EPS* Reconciliation

| | 2009 | 2010 | 2011 | 2012 | 2013 | 2014 | 2015 | 2016 | 2017 |
|--|-----------|---------|---------|---------|---------|---------|---------|---------|---------|
| GAAP EPS from Continuing Operations, as reported | \$ (0.48) | \$ 1.48 | \$ 2.74 | \$ 2.66 | \$ 2.07 | \$ 2.56 | \$ 3.09 | \$ 2.88 | \$ 2.75 |
| Restructuring Costs and Other Expense (Income), net of tax | 0.24 | (0.07) | (0.13) | 0.03 | - | 0.05 | 0.03 | (0.02) | 0.01 |
| Acquisition Costs, net of tax | - | - | - | - | - | - | - | 0.15 | 0.39 |
| Amortization of Acquired Profit in Inventory and Backlog, net of tax | - | - | - | - | 0.17 | 0.17 | 0.01 | 0.12 | 0.43 |
| Discrete Tax Items | 0.37 | - | (0.51) | (0.40) | - | - | - | (0.02) | 0.90 |
| Adjusted EPS* | \$ 0.13 | \$ 1.41 | \$ 2.10 | \$ 2.29 | \$ 2.24 | \$ 2.78 | \$ 3.13 | \$ 3.10 | \$ 4.49 |

Adjusted EPS* Reconciliation

| | 2018 | 2019 | 2020 | 2021 | 2022 | 2023 |
|--|---------|---------|---------|---------|----------|----------|
| GAAP EPS, as reported | \$ 5.30 | \$ 4.54 | \$ 4.77 | \$ 7.21 | \$ 10.35 | \$ 9.90 |
| Settlement and Curtailment Losses, net of tax | 0.09 | 0.55 | - | - | - | - |
| Gain on Sale of Buildings and Other Income, net of tax | - | - | - | (0.03) | (1.30) | (0.05) |
| Impairment and Restructuring Costs, net of tax | 0.11 | 0.17 | 0.19 | 0.08 | 0.11 | 0.04 |
| Relocation Costs, net of tax | - | - | - | - | - | 0.05 |
| Acquisition Costs, net of tax | 0.10 | 0.06 | 0.03 | 0.26 | 0.04 | 0.10 |
| Amortization of Acquired Profit in Inventory and Backlog, net of tax | 0.02 | 0.32 | 0.04 | 0.34 | 0.03 | - |
| Discrete Tax Items | (0.29) | (0.29) | (0.03) | (0.04) | - | - |
| Adjusted EPS* | \$ 5.34 | \$ 5.36 | \$ 5.00 | \$ 7.83 | \$ 9.24 | \$ 10.04 |

Adjusted Free Cash Flow* Reconciliation

| (\$ in millions) | 2018 | 2019 | 2020 | 2021 | 2022 | 2023 |
|--|---------|---------|---------|----------|----------|----------|
| Operating Cash Flow, as reported | \$ 63.0 | \$ 97.4 | \$ 92.9 | \$ 162.4 | \$ 102.6 | \$ 165.5 |
| Capital Expenditures, as reported | (16.6) | (9.9) | (7.6) | (12.8) | (28.2) | (31.8) |
| Free Cash Flow* | \$ 46.4 | \$ 87.5 | \$ 85.3 | \$ 149.6 | \$ 74.4 | \$ 133.7 |
| Capital Expenditures for Facility Projects | 6.4 | - | - | - | 10.4 | 7.4 |
| Adjusted Free Cash Flow* | \$ 52.8 | \$ 87.5 | \$ 85.3 | \$ 149.6 | \$ 84.8 | \$ 141.1 |

Adjusted EBITDA* Reconciliation

| (\$ in millions) | 2009 | 2010 | 2011 | 2012 | 2013 | 2014 | 2015 | 2016 | 2017 |
|---|----------|---------|---------|---------|---------|---------|---------|---------|---------|
| Net Income Attributable to Kadant | \$ (5.9) | \$ 18.5 | \$ 33.6 | \$ 31.6 | \$ 23.4 | \$ 28.7 | \$ 34.4 | \$ 32.1 | \$ 31.1 |
| Net Income Attributable to Noncontrolling Interest | - | 0.3 | 0.3 | 0.2 | 0.2 | 0.4 | 0.3 | 0.4 | 0.5 |
| Provision for Income Taxes | 3.7 | 5.2 | 4.3 | 4.8 | 9.3 | 12.4 | 14.7 | 12.1 | 26.1 |
| Interest Expense, net | 1.8 | 1.1 | 0.5 | 0.5 | 0.3 | 0.6 | 0.7 | 1.0 | 3.1 |
| (Income) Loss from Discontinued Operations and Other Expense, net | - | (0.1) | - | (0.7) | 0.1 | - | - | - | 0.9 |
| Operating Income (Loss) | \$ (0.4) | \$ 25.0 | \$ 38.7 | \$ 36.4 | \$ 33.3 | \$ 42.1 | \$ 50.1 | \$ 45.6 | \$ 61.7 |
| Restructuring Costs and Other Income | 4.4 | (1.1) | (1.9) | - | 0.1 | 0.8 | 0.5 | (0.3) | 0.2 |
| Acquisition Costs | - | - | - | - | - | - | - | 1.8 | 5.4 |
| Acquired Profit in Inventory and Backlog Amortization | - | - | - | - | 2.6 | 2.6 | 0.2 | 1.9 | 6.5 |
| Adjusted Operating Income* | \$ 4.0 | \$ 23.9 | \$ 36.8 | \$ 36.4 | \$ 36.0 | \$ 45.5 | \$ 50.8 | \$ 49.0 | \$ 73.8 |
| Depreciation and Amortization | 7.4 | 7.3 | 8.0 | 8.4 | 8.7 | 10.8 | 10.7 | 12.9 | 17.9 |
| Adjusted EBITDA* | \$ 11.4 | \$ 31.2 | \$ 44.8 | \$ 44.8 | \$ 44.7 | \$ 56.3 | \$ 61.5 | \$ 61.9 | \$ 91.7 |
| Revenue | \$225.6 | \$270.0 | \$335.5 | \$331.8 | \$344.5 | \$402.1 | \$390.1 | \$414.1 | \$515.0 |
| Adjusted EBITDA Margin* | 5.1% | 11.5% | 13.3% | 13.5% | 13.0% | 14.0% | 15.8% | 14.9% | 17.8% |

Adjusted EBITDA* Reconciliation

| (\$ in millions) | 2018 | 2019 | 2020 | 2021 | 2022 | 2023 |
|---|----------|----------|----------|----------|----------|----------|
| Net Income Attributable to Kadant | \$ 60.4 | \$ 52.1 | \$ 55.2 | \$ 84.0 | \$ 120.9 | \$ 116.1 |
| Net Income Attributable to Noncontrolling Interest | 0.6 | 0.5 | 0.5 | 0.8 | 0.8 | 0.7 |
| Provision for Income Taxes | 18.5 | 16.3 | 17.9 | 27.2 | 43.9 | 42.2 |
| Interest Expense, net | 6.7 | 12.5 | 7.2 | 4.6 | 5.6 | 6.7 |
| Other Expense, net | 2.4 | 6.4 | 0.3 | 0.1 | 0.1 | 0.1 |
| Operating Income | \$ 88.6 | \$ 87.8 | \$ 81.1 | \$ 116.7 | \$ 171.3 | \$ 165.8 |
| Gain on Sale of Buildings and Other Income | - | - | - | (0.5) | (20.2) | (0.9) |
| Indemnification Asset Reversals | - | - | - | - | 1.3 | 0.1 |
| Impairment and Restructuring Costs | 1.7 | 2.5 | 3.0 | 1.0 | 1.3 | 0.8 |
| Relocation Costs | - | - | - | - | - | 0.8 |
| Acquisition Costs | 1.3 | 0.8 | 0.5 | 3.6 | 0.7 | 1.4 |
| Acquired Profit in Inventory and Backlog Amortization | 0.3 | 4.9 | 0.5 | 5.6 | 0.5 | - |
| Adjusted Operating Income* | \$ 91.9 | \$ 96.0 | \$ 85.1 | \$ 126.4 | \$ 154.9 | \$ 168.0 |
| Depreciation and Amortization | 23.3 | 31.1 | 30.8 | 33.0 | 34.2 | 33.3 |
| Adjusted EBITDA* | \$ 115.2 | \$ 127.1 | \$ 115.9 | \$ 159.4 | \$ 189.1 | \$ 201.3 |
| Revenue | \$ 633.8 | \$ 704.6 | \$ 635.0 | \$ 786.6 | \$ 904.7 | \$ 957.7 |
| Adjusted EBITDA Margin* | 18.2% | 18.0% | 18.3% | 20.3% | 20.9% | 21.0% |

Adjusted SG&A* Reconciliation

| (\$ in millions) | 2009 | 2010 | 2011 | 2012 | 2013 | 2014 | 2015 | 2016 | 2017 |
|----------------------------------|----------|----------|----------|----------|----------|----------|----------|----------|----------|
| SG&A | \$ 81.2 | \$ 89.2 | \$ 102.7 | \$ 103.1 | \$ 117.6 | \$ 129.3 | \$ 122.8 | \$ 134.8 | \$ 159.8 |
| Acquisition Costs | - | - | (0.2) | (0.2) | (1.8) | (0.3) | - | (1.8) | (5.4) |
| Amortization of Acquired Backlog | - | - | - | - | (1.1) | (0.4) | (0.1) | (1.5) | (1.4) |
| Adjusted SG&A* | \$ 81.2 | \$ 89.2 | \$ 102.5 | \$ 102.9 | \$ 114.7 | \$ 128.6 | \$ 122.7 | \$ 131.5 | \$ 153.0 |
| Revenue | \$ 225.6 | \$ 270.0 | \$ 335.5 | \$ 331.8 | \$ 344.5 | \$ 402.1 | \$ 390.1 | \$ 414.1 | \$ 515.0 |
| Adjusted SG&A as a % of Revenue* | 36.0% | 33.0% | 30.6% | 31.0% | 33.3% | 32.0% | 31.5% | 31.8% | 29.7% |

Adjusted SG&A* Reconciliation

| (\$ in millions) | 2018 | 2019 | 2020 | 2021 | 2022 | 2023 |
|----------------------------------|----------|----------|----------|----------|----------|----------|
| SG&A | \$ 177.4 | \$ 192.5 | \$ 181.9 | \$ 208.8 | \$ 224.4 | \$ 236.3 |
| Government Assistance Programs | - | - | 2.2 | 1.4 | - | - |
| Acquisition Costs | (1.3) | (0.8) | (0.5) | (3.6) | (0.7) | (1.4) |
| Amortization of Acquired Backlog | (0.3) | (1.3) | (0.5) | (1.4) | (0.7) | - |
| Indemnification Asset Reversals | - | - | - | - | (1.3) | (0.1) |
| Adjusted SG&A* | \$ 175.8 | \$ 190.4 | \$ 183.1 | \$ 205.2 | \$ 221.7 | \$ 234.8 |
| Revenue | \$ 633.8 | \$ 704.6 | \$ 635.0 | \$ 786.6 | \$ 904.7 | \$ 957.7 |
| Adjusted SG&A as a % of Revenue* | 27.7% | 27.0% | 28.8% | 26.1% | 24.5% | 24.5% |

Notes

PRESENTATION NOTES

- All references to EPS (earnings per share) are to our EPS as calculated on a diluted basis.
- Specific non-GAAP financial measures have been marked with an * (asterisk) within this presentation. A reconciliation of those numbers to the most directly comparable GAAP financial measures is shown in the Appendix.
- All third-party company names, logos, product names, trademarks, and copyrights are property of their respective owners.

FOOTNOTES

- 1) Percent of total FY 2023 revenue.
- 2) Percent of FY 2023 aftermarket parts revenue within the segment.
- 3) Company estimate based on Company information and not derived from published studies or other market data unless otherwise noted.
- 4) Fiber Processing was formerly referred to as the stock-preparation product line.
- 5) Return on invested capital (ROIC) is defined as adjusted net income less dividends divided by the average of the last four quarters' total capital. Total capital equals (total assets – cash – goodwill) less (current liabilities – current debt)
- 6) Adjusted return on invested capital (ROIC) is calculated based on adjusted net income, excluding intangible amortization, over consideration paid net of cash acquired. Average adjusted ROIC is calculated using the adjusted ROIC for each acquisition weighted based on consideration paid net of cash acquired.
- 7) Leverage ratio is calculated by dividing total debt by EBITDA. For purposes of this calculation, EBITDA is calculated by adding or subtracting certain items from Adjusted EBITDA, as required by our amended and restated credit facility (“Credit Facility”). Our Credit Facility defines total debt as debt less worldwide cash of up to \$50 million.